

Industrial ORP Probe

Reads	ORP
Range	+/- 2000 mV
Response time	95% in 1s
Max pressure	100 PSI
Max depth	60m (197 ft)
Temperature range °C	1 – 99 °C
Cable length	3 meters
Internal temperature sensor	No
Time before recalibration	~1 Year
Life expectancy	~4 Years +
Maintenance	N/A



Specifications

Body material	Ryton thermoplastic
Max depth	60m (197 ft)
Cable length	3m (10 feet)
Weight	250 grams
Threading	20mm (3/4") NPT
Sterilization	Chemical only

This ORP probe can be **fully submerged** in fresh or salt water, up to the tinned leads **indefinitely**.



Industrial ORP probe cap

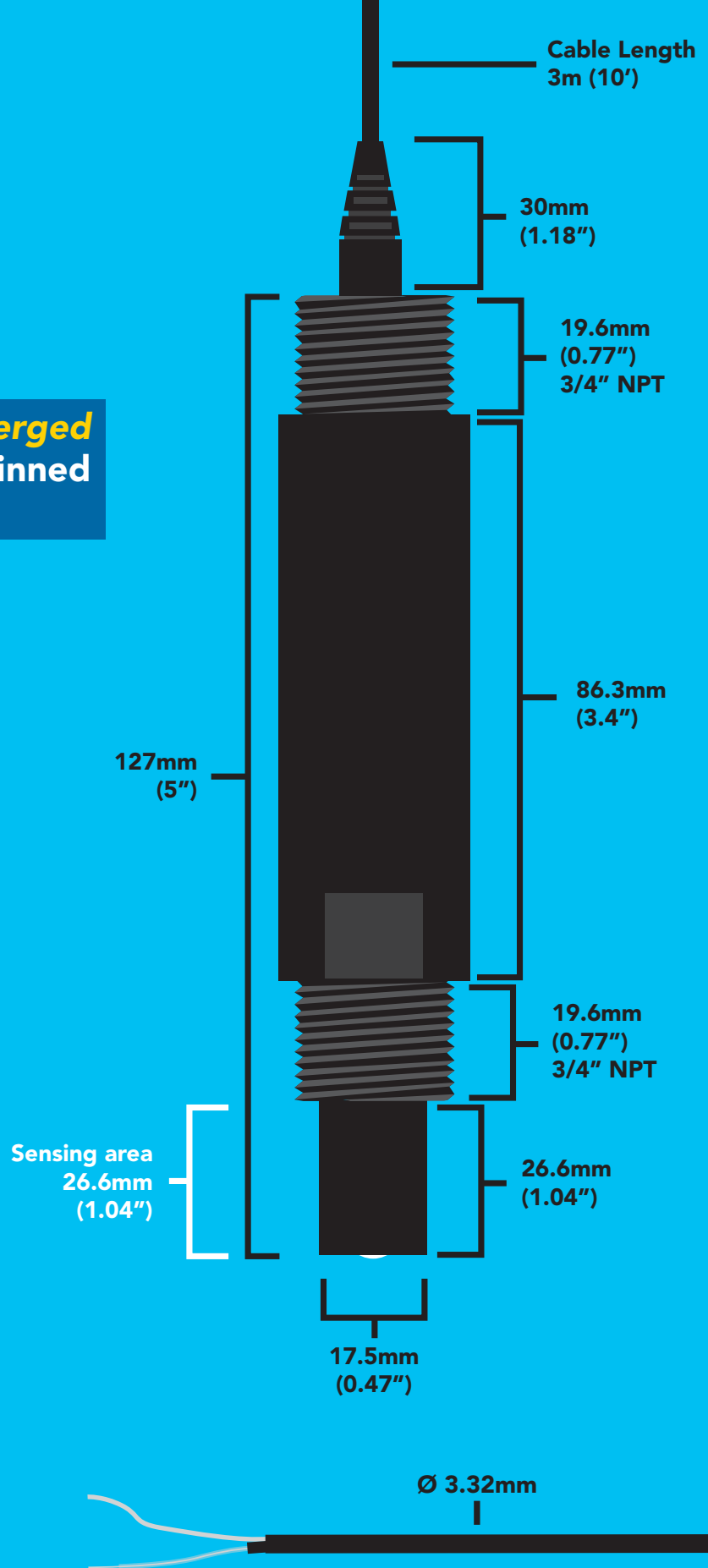

Operating principle

ORP stands for **oxidation/reduction potential**. Oxidation is the loss of electrons and reduction is the gain of electrons. The output of the probe is represented in millivolts and can be positive or negative.

Just like a pH probe measures hydrogen ion activity in a liquid; an ORP probe measures electron activity in a liquid. The ORP readings represents how strongly electrons are transferred to or from substances in a liquid. Keeping in mind that the readings do not indicate the amount of electrons available for transfer.

pH Probe



ORP Probe

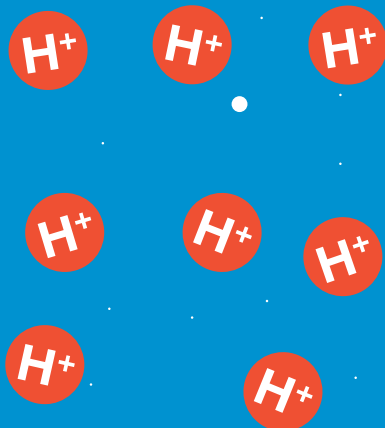

When reading the ORP of a liquid that has very few electronics available for transfer ORP readings can appear to be inconsistent.

The water is unreactive and has only trace amounts of electron movement. *These readings are equivalent to the readings you see with an unconnected multimeter.*

-234.6
Reading A

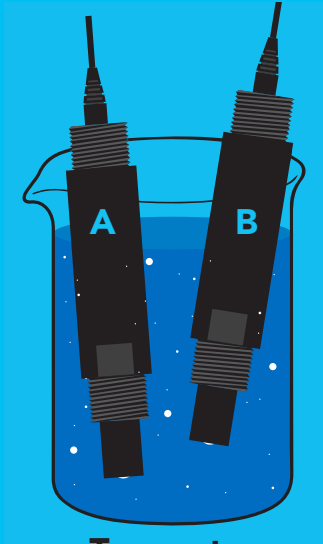

Tap water

24.2
Reading B

606.9
Reading A

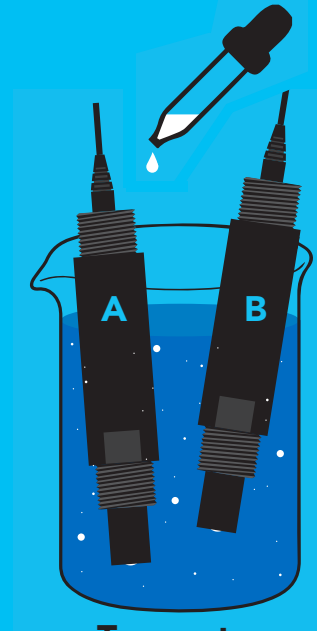

Tap water

**Add just a drop of bleach
(which is an oxidizing agent)**

605.3
Reading B

An ORP probe has a platinum tip that is connected to a silver wire, surrounded by silver chloride. That silver wire is then connected to a KCL reference solution. Because platinum is an unreactive metal it can “silently observe” the electron activity of the liquid without becoming apart of whatever reaction is occurring in the liquid.



Silver wire

Junction

Silver chloride

KCL reference solution

Reference wire

An ORP probe is a passive device that detects a current generated from the oxidation or reduction chemical substances in water. This current (which can be positive or negative) is very weak and cannot be detected with a multimeter, or an analog to digital converter.



Result will **Often** read zero.

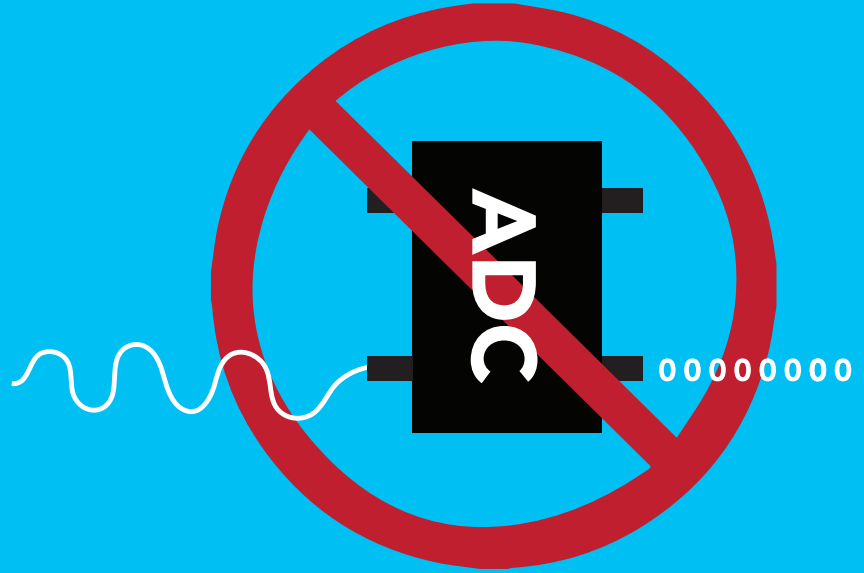

Result will **Often** read zero.

How often do you need to recalibrate an ORP probe?

Because every use case is different, there is no set schedule for recalibration.

If you are using your probe in a fish tank, a hydroponic system or any environment that has generally weak levels of chemical reactions you will only need to recalibrate your probe once per year for the first 2 years. After that every ~6 months.

If you are using the ORP probe in batch chemical manufacturing, industrial process, or in a solution that is known to have strong chemical reactions, then calibration should be done monthly or in extreme cases after each batch.

How to connect the industrial ORP probe

The Atlas Scientific™ Industrial ORP probe can be connected in several different ways. The following show two examples:

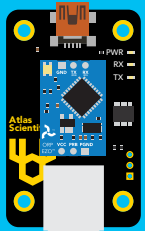

Using **BNC with Terminal Screws**, you can easily connect the Industrial ORP Probe to our **EZO™ ORP Circuit** via our **Electrically Isolated USB EZO™ Carrier Board**.

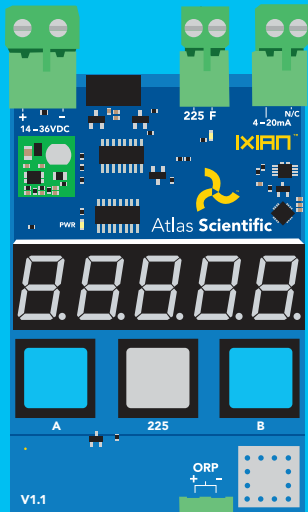

For industrial purposes, the Industrial ORP probe connects easily to our **IXIAN™ ORP Transmitter**.



ORP probes must stay wet and cannot be allowed to dry out, this is why every Industrial ORP probe is shipped with a plastic cap containing ORP probe storage solution. The cap should remain on the probe until it is used.

Remove the Industrial ORP probe cap by turning it clockwise, and pulling the probe out. Make sure to slide the O-ring off the probe.

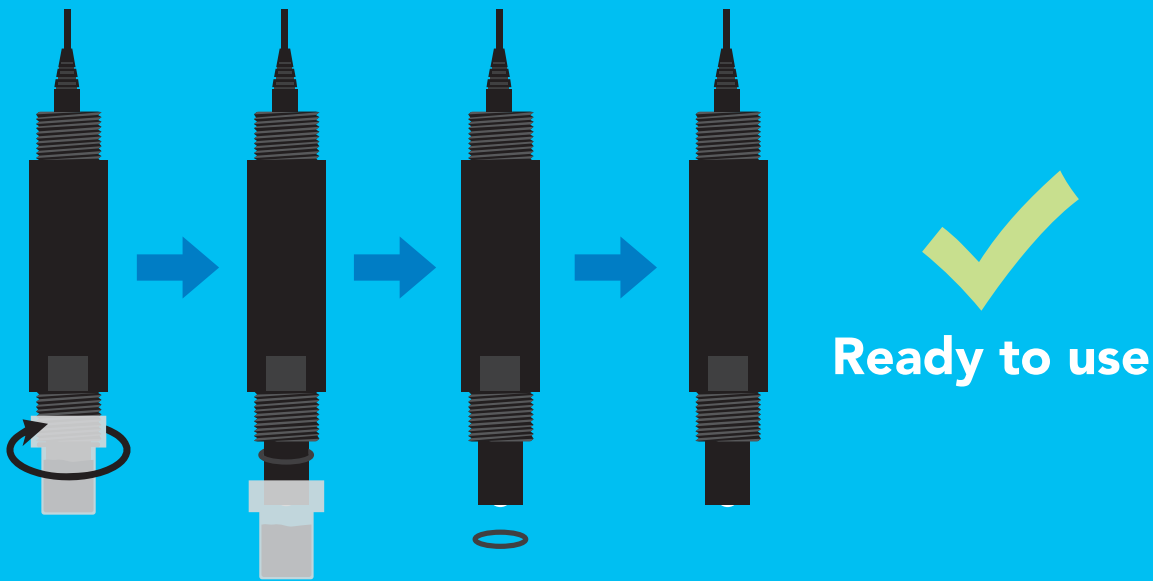

Probe cleaning

Coating of the ORP bulb can lead to erroneous readings including shortened span (slope). The type of coating will determine the cleaning technique. Soft coatings can be removed by vigorous stirring or by the use of a squirt bottle. Organic chemical, or hard coatings, should be chemically removed. A light bleach solution or even a 5 – 10% hydrochloric acid (HCl) soak for a few minutes, often removes many coatings. **Do not use abrasive materials on the ORP probe.**

