

pH EZOTM

Circuit

Reads	pH
Range	.001 – 14.000
Resolution	.001
Accuracy	+/- 0.002
Max rate	1 reading per sec
Supported probes	Any type & brand
Calibration	1, 2, 3 point
Temp compensation	Yes
Data protocol	UART & I ² C
Default I ² C address	99 (0x63)
Operating voltage	3.3V – 5V
Data format	ASCII

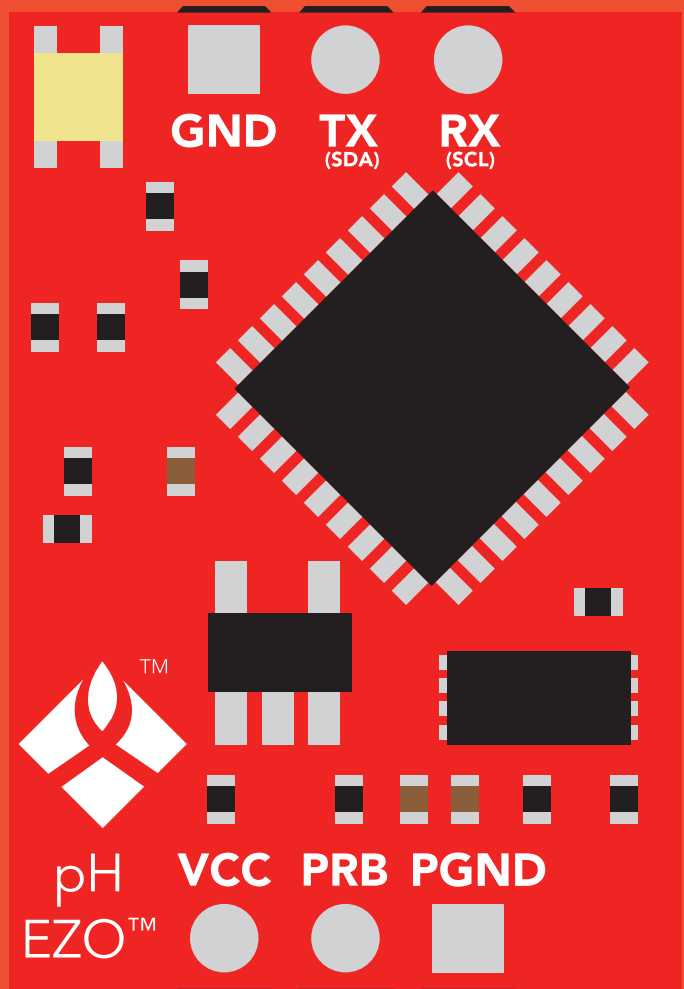

PATENT PROTECTED



STOP

SOLDERING THIS DEVICE VOIDS YOUR WARRANTY.

This is sensitive electronic equipment. Get this device working in a solderless breadboard first. Once this device has been soldered it is no longer covered by our warranty.

This device has been designed to be soldered and can be soldered at any time. Once that decision has been made, Atlas Scientific no longer assumes responsibility for the device's continued operation. The embedded systems engineer is now the responsible party.

Get this device working in a solderless breadboard first!

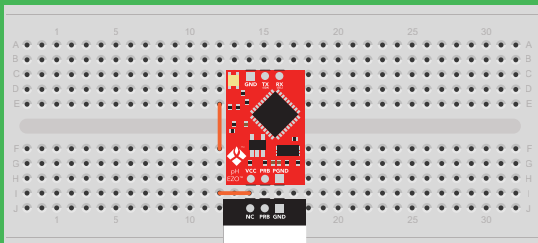

Do not embed this device without testing it in a solderless breadboard!

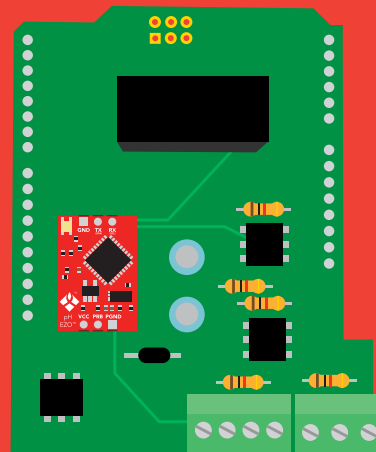

Table of contents

Circuit dimensions	4	Calibration theory	7
Power consumption	4	Power and data isolation	9
Absolute max ratings	4	Correct wiring	11
EZO™ circuit identification	5	Available data protocols	14
Operating principle	6		

UART

UART mode	16
Default state	17
Receiving data from device	18
Sending commands to device	19
LED color definition	20
UART quick command page	21
LED control	22
Find	23
Continuous reading mode	24
Single reading mode	25
Calibration	26
Export/import calibration	27
Slope	28
Temperature compensation	29
Naming device	30
Device information	31
Response codes	32
Reading device status	33
Sleep mode/low power	34
Change baud rate	35
Protocol lock	36
Factory reset	37
Change to I ² C mode	38
Manual switching to I ² C	39

I²C

I ² C mode	41
Sending commands	42
Requesting data	43
Response codes	44
LED color definition	45
I²C quick command page	46
LED control	47
Find	48
Taking reading	49
Calibration	50
Export/import calibration	51
Slope	52
Temperature compensation	53
Device information	54
Reading device status	55
Sleep mode/low power	56
Protocol lock	57
I ² C address change	58
Factory reset	59
Change to UART mode	60
Manual switching to UART	61

Circuit footprint	62
Datasheet change log	63
Warranty	65

EZO™ circuit dimensions

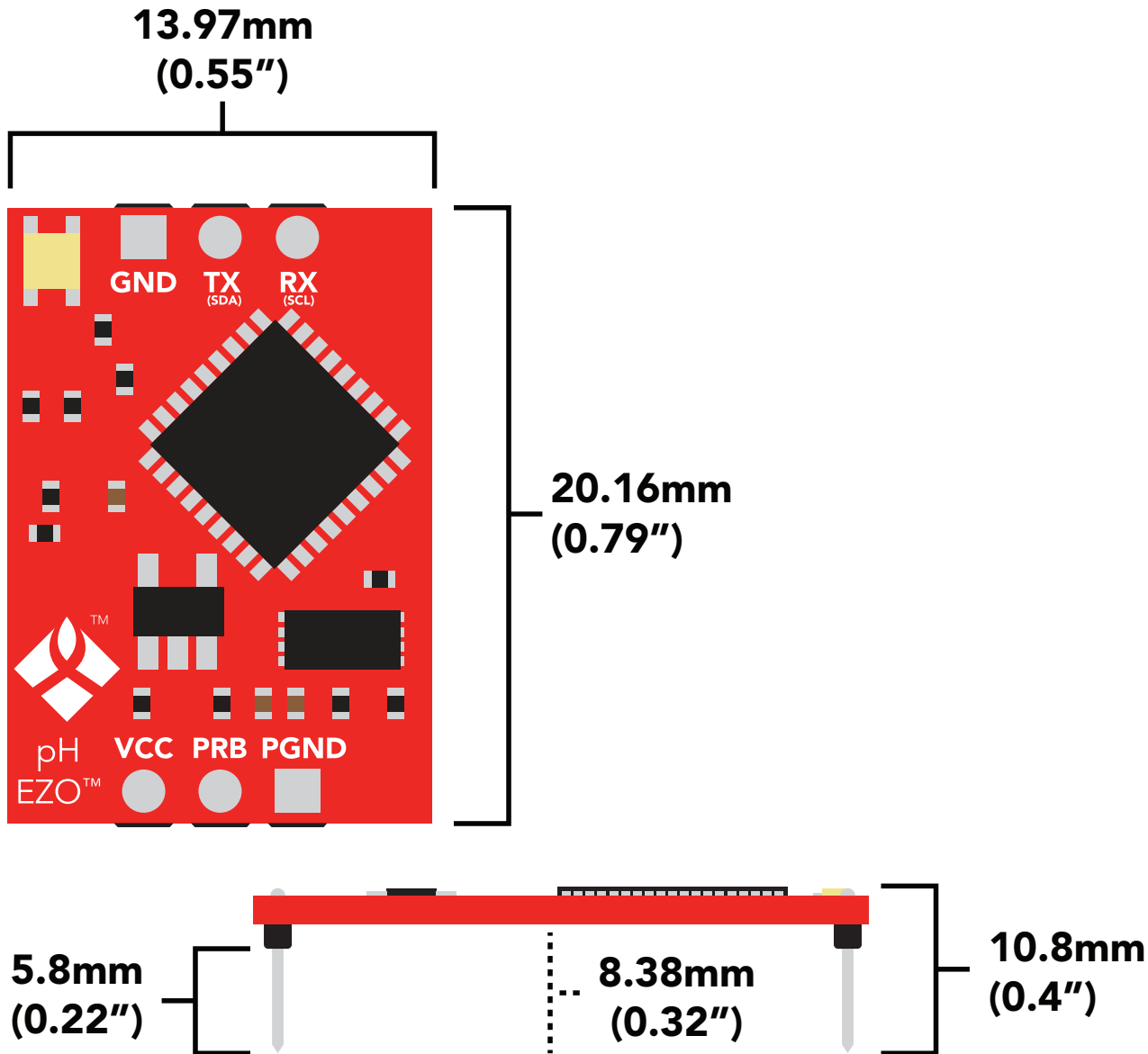

Power consumption

	LED	MAX	STANDBY	SLEEP
5V	ON	18.3 mA	16 mA	1.16 mA
	OFF	13.8 mA	13.8 mA	
3.3V	ON	14.5 mA	13.9 mA	0.995 mA
	OFF	13.3 mA	13.3 mA	

Absolute max ratings

Parameter	MIN	TYP	MAX
Storage temperature (EZO™ pH)	-65 °C		125 °C
Operational temperature (EZO™ pH)	-40 °C	25 °C	85 °C
VCC	3.3V	5V	5.5V

EZO™ circuit identification

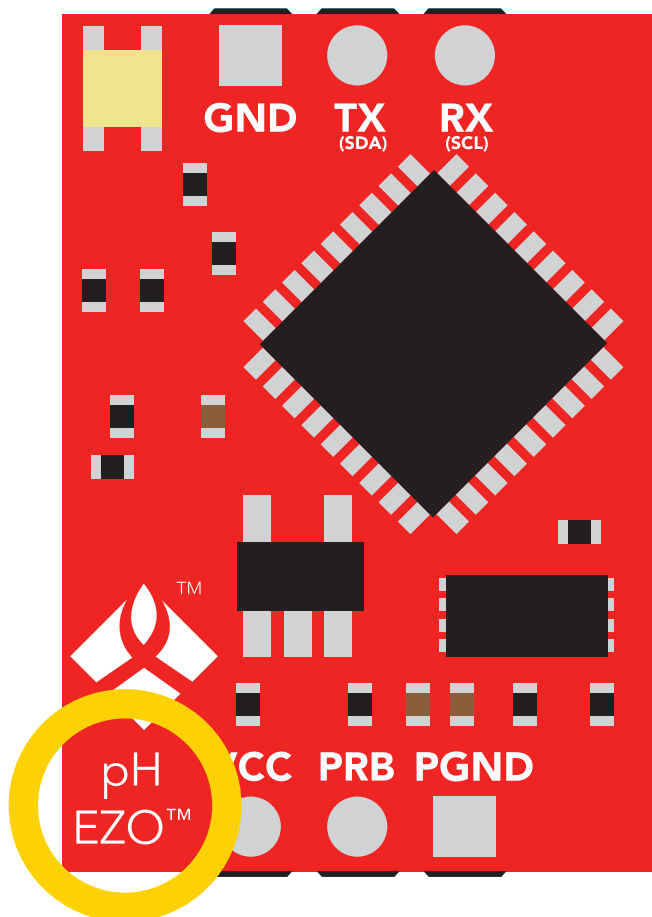

EZO™ pH circuit



Viewing correct datasheet

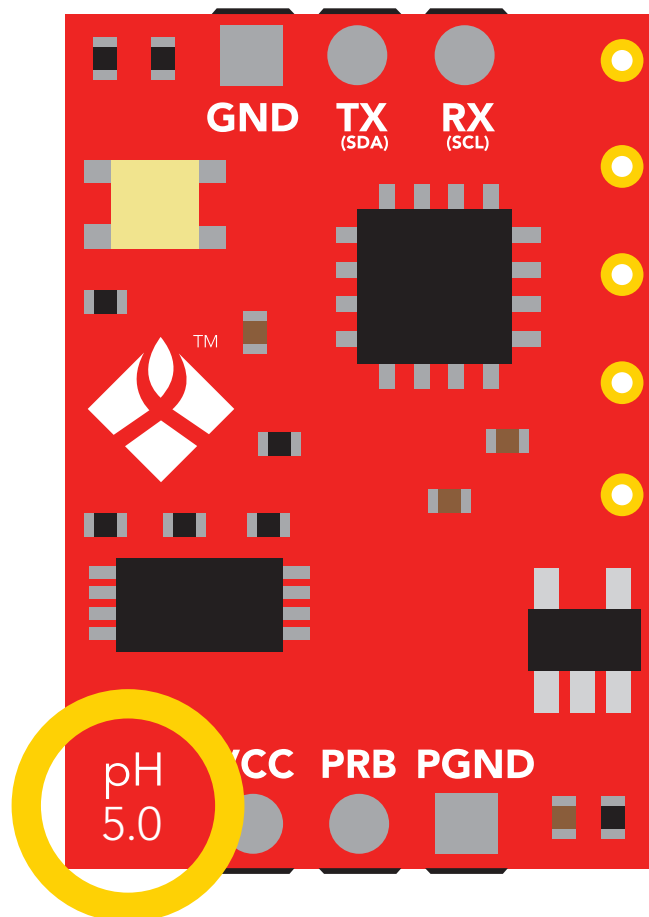

Legacy pH circuit



Viewing incorrect datasheet

[Click here to view legacy datasheet](#)

Operating principle

A pH (**potential of Hydrogen**) probe measures the hydrogen ion activity in a liquid. At the tip of a pH probe is a glass membrane. This glass membrane permits hydrogen ions from the liquid being measured to diffuse into the outer layer of the glass, while larger ions remain in the solution. The difference in the concentration of hydrogen ions (outside the probe vs. inside the probe) creates a VERY small current. This current is proportional to the concentration of hydrogen ions in the liquid being measured.

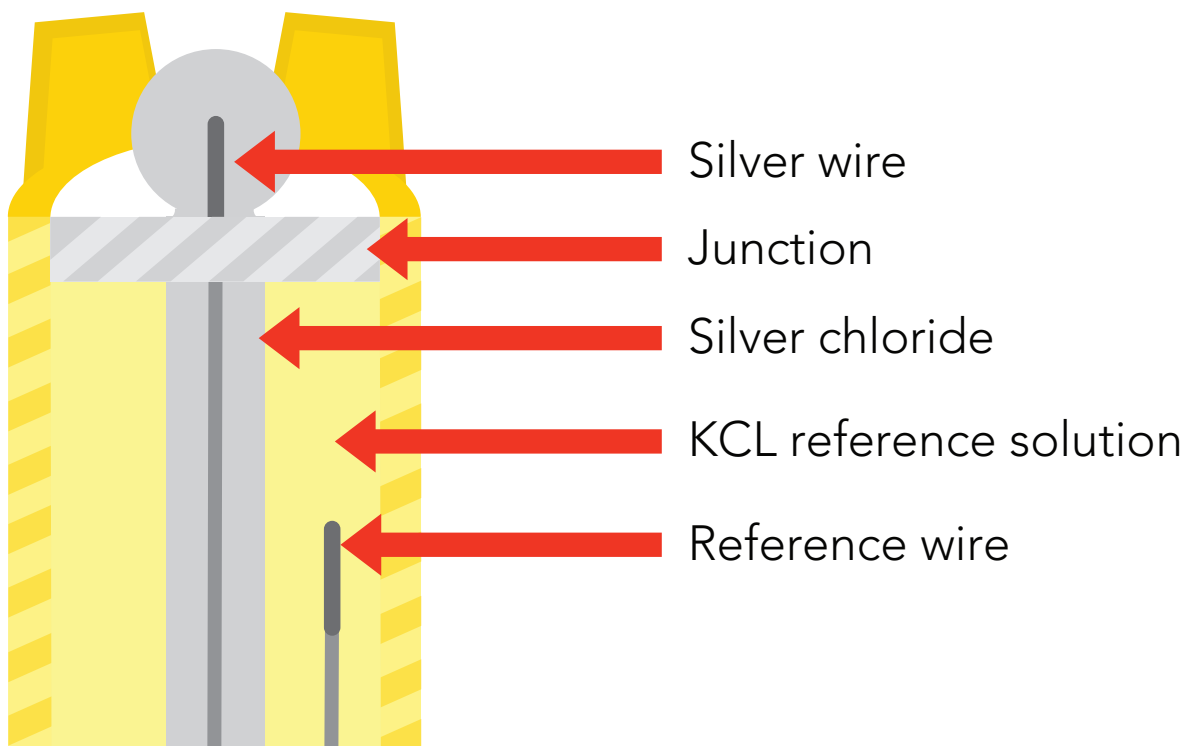
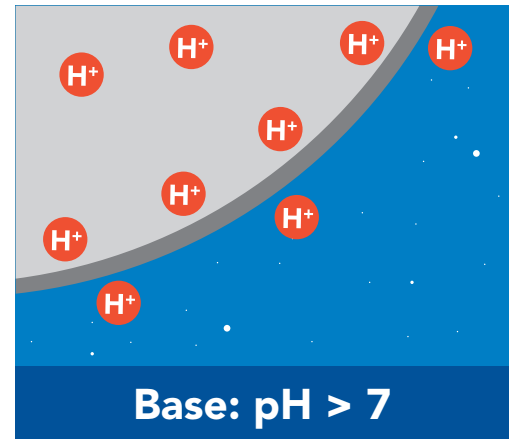
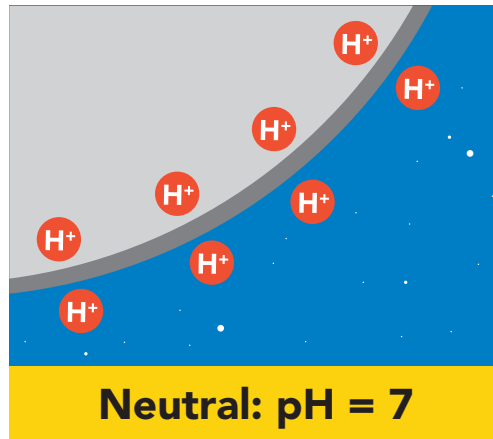
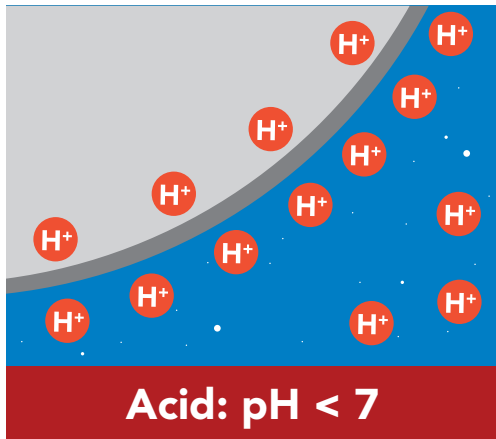

Calibration theory

The Atlas Scientific EZO™ class pH circuit has a flexible calibration protocol, allowing for **single point**, **two point**, or **three point** calibration.

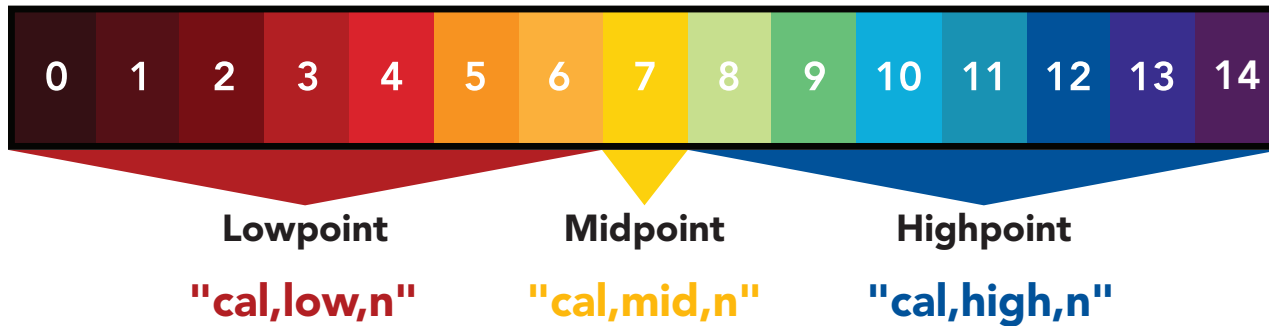

The first calibration point must be the Midpoint (pH 7)

The EZO™ pH circuits default temperature compensation is set to 25° C. If the temperature of the calibration solution is +/- 2° C from 25° C, consider setting the temperature compensation first. **Temperature changes of < 2° C are insignificant.**

Single point calibration

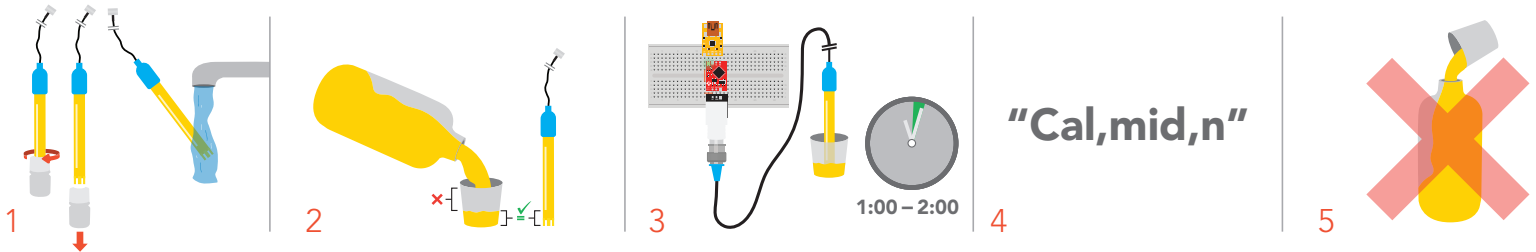

1. Remove soaker bottle and rinse off pH probe.
2. Pour a small amount of the calibration solution into a cup.
3. Let the probe sit in calibration solution until readings stabilize (1 – 2 minutes).
4. Calibrate the midpoint value using the command **"Cal,mid,n"**.
Where "n" is any floating point value that represents the calibration midpoint.
5. Do not pour the calibration solution back into the bottle.

Two point calibration

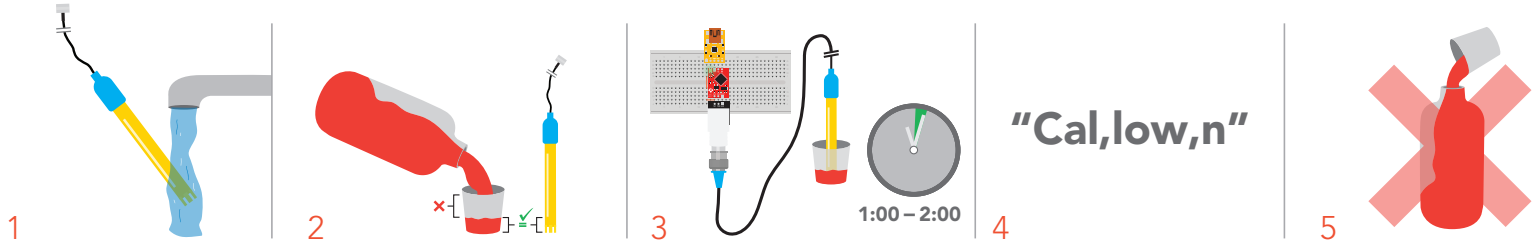

1. Rinse off pH probe.
2. Pour a small amount of the calibration solution into a cup
3. Let the probe sit in calibration solution until readings stabilize (1 – 2 minutes).
4. Calibrate the lowpoint value using the command **"Cal,low,n"**.
Where "n" is any floating point value that represents the calibration lowpoint.
5. Do not pour the calibration solution back into the bottle.

Three point calibration

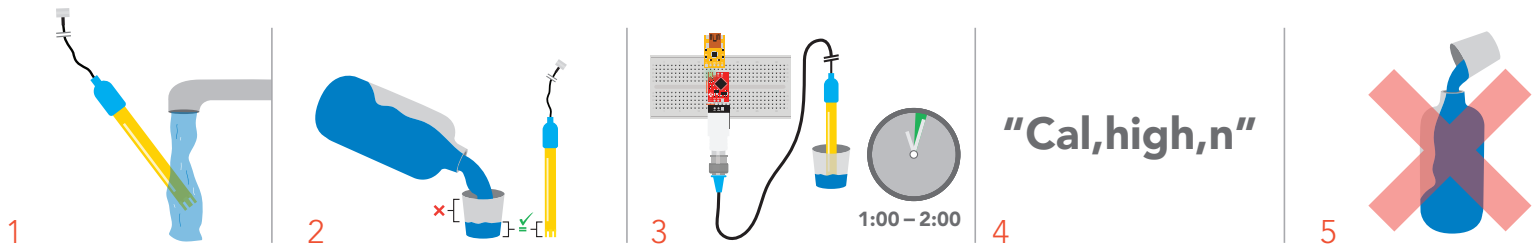

1. Rinse off pH probe.
2. Pour a small amount of the calibration solution into a cup
3. Let the probe sit in calibration solution until readings stabilize (1 – 2 minutes).
4. Calibrate the highpoint value using the command **"Cal,high,n"**.
Where "n" is any floating point value that represents the calibration highpoint.
5. Do not pour the calibration solution back into the bottle.



Issuing the cal,mid command after the EZO™ pH circuit has been calibrated will clear the other calibration points. Full calibration will have to be redone.



Power and data isolation

The Atlas Scientific EZO™ pH circuit is a very sensitive device. This sensitivity is what gives the pH circuit its accuracy. This also means that the pH circuit is capable of reading micro-voltages that are bleeding into the water from unnatural sources such as pumps, solenoid valves or other probes/sensors.

When electrical noise is interfering with the pH readings it is common to see rapidly fluctuating readings or readings that are consistently off. To verify that electrical noise is causing inaccurate readings, place the pH probe in a cup of water by itself. The readings should stabilize quickly, confirming that electrical noise was the issue.



When reading pH and Conductivity or Dissolved Oxygen together, it is **strongly recommended** that the EZO™ pH circuit is electrically isolated from the EZO™ Conductivity or Dissolved Oxygen circuit.

Basic EZO™
Inline Voltage Isolator

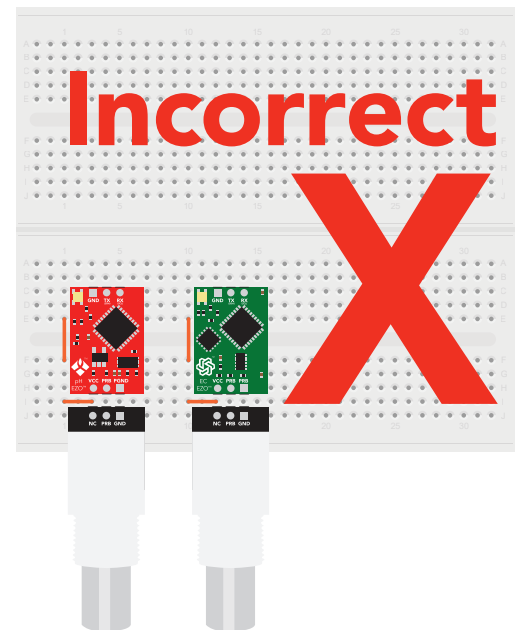
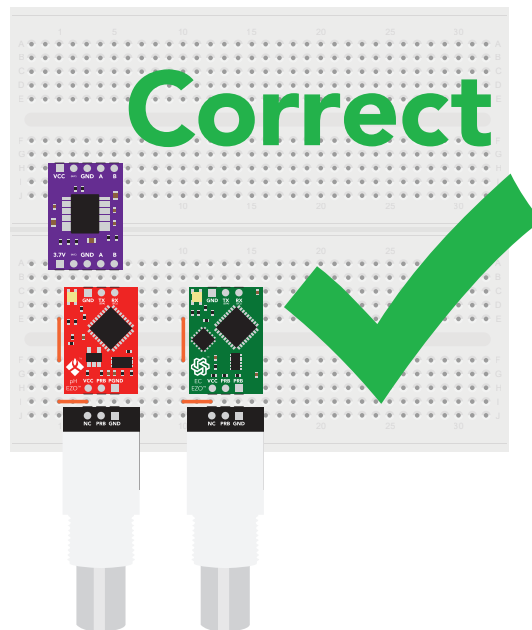

Without isolation, Conductivity and Dissolved Oxygen readings will effect pH accuracy.

This schematic shows exactly how we isolate data and power using the [ADM3260](#) and a few passive components. The ADM3260 can output isolated power up to 150 mW and incorporates two bidirectional data channels.

This technology works by using tiny transformers to induce the voltage across an air gap. PCB layout requires special attention for EMI/EMC and RF Control, having proper ground planes and keeping the capacitors as close to the chip as possible are crucial for proper performance. The two data channels have a 4.7kΩ pull up resistor on both the isolated and non-isolated lines (R1, R2, R3, and R4) The output voltage is set using a voltage divider (R5, R6, and R7) this produces a voltage of 3.7V regardless of your input voltage.

Isolated ground is different from non-isolated ground, these two lines should not be connected together.

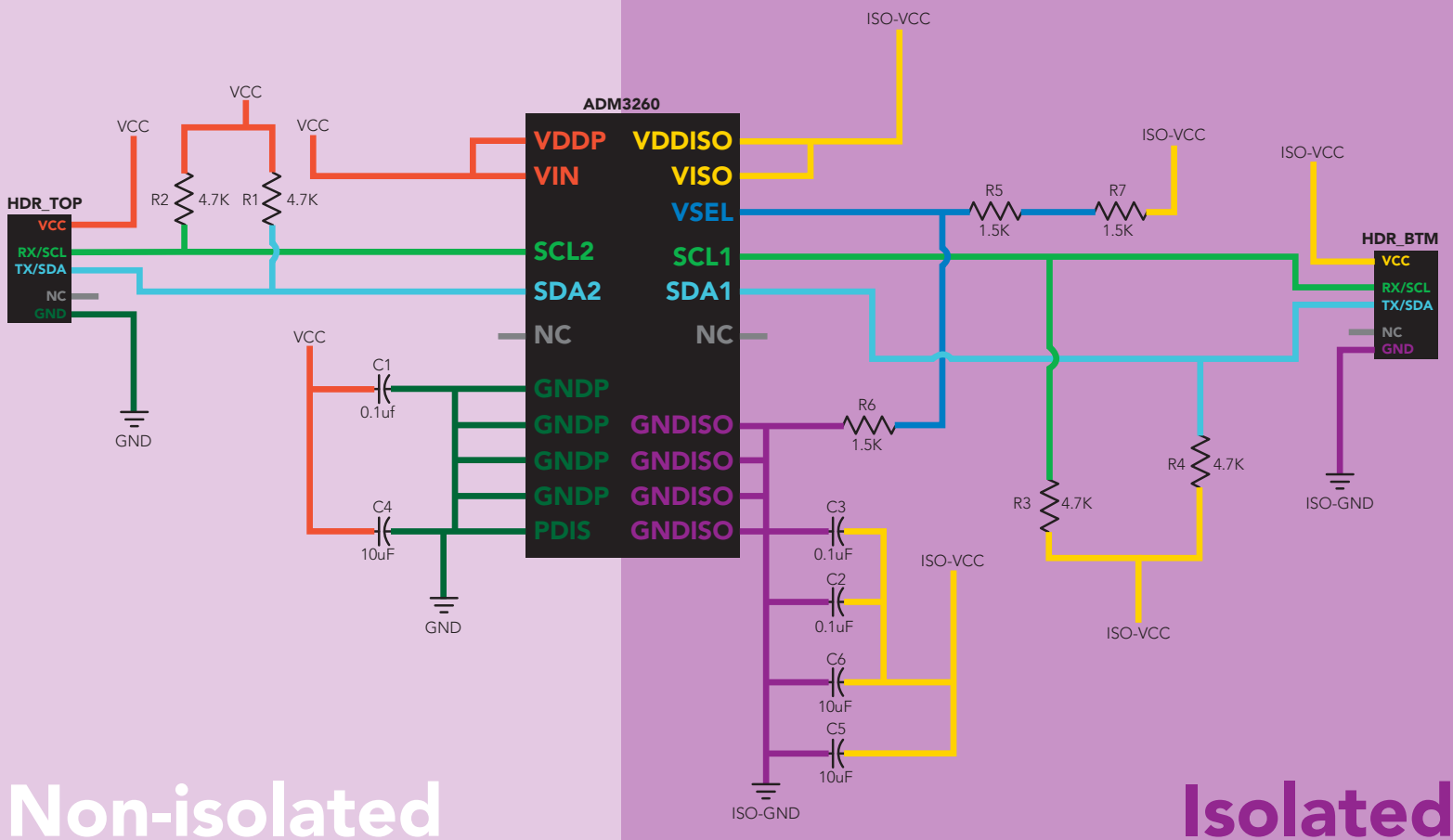

✓ Correct wiring

Bread board

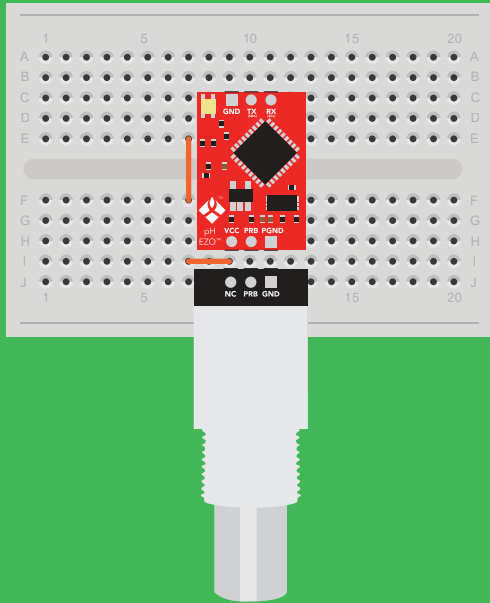

Bread board via USB

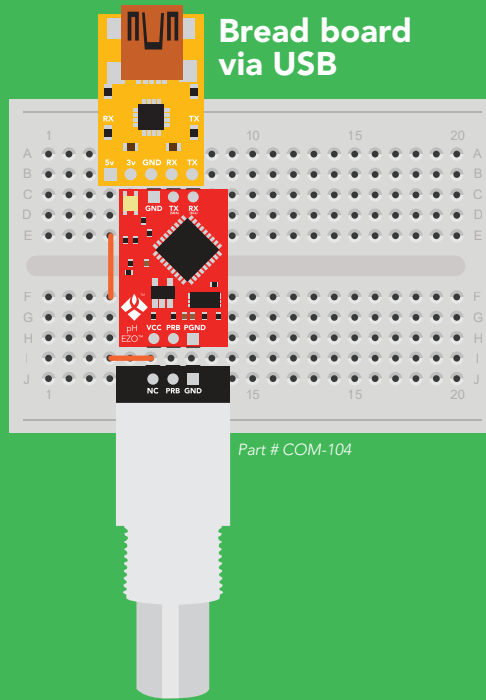

Carrier board

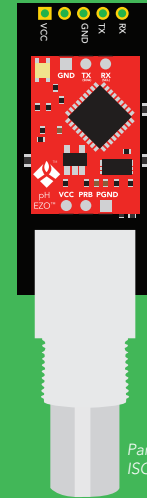

USB carrier board

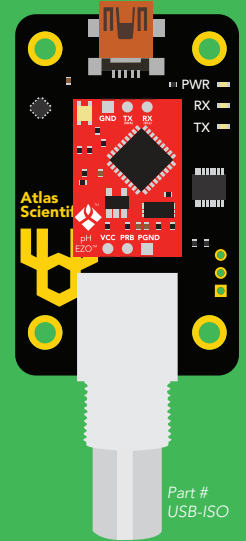

X Incorrect wiring

Extended leads

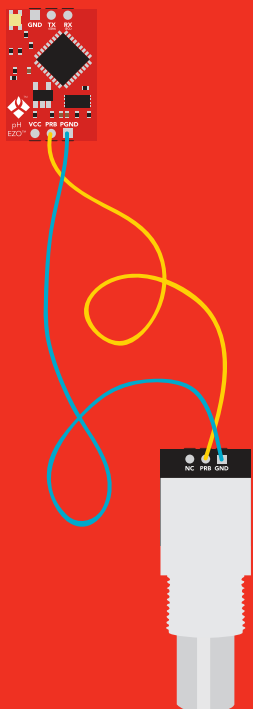

Sloppy setup

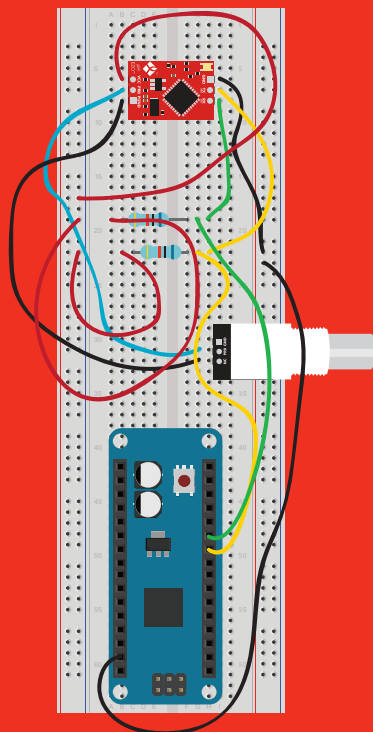

Perfboards or Protoboards

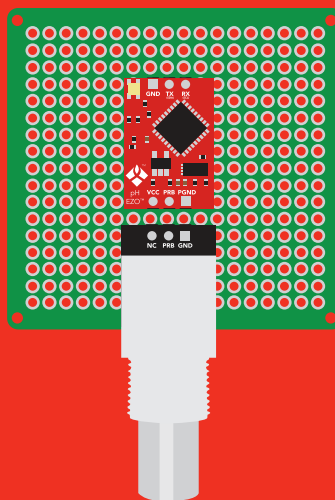

NEVER
use Perfboards
or Protoboards

*Embedded into your device

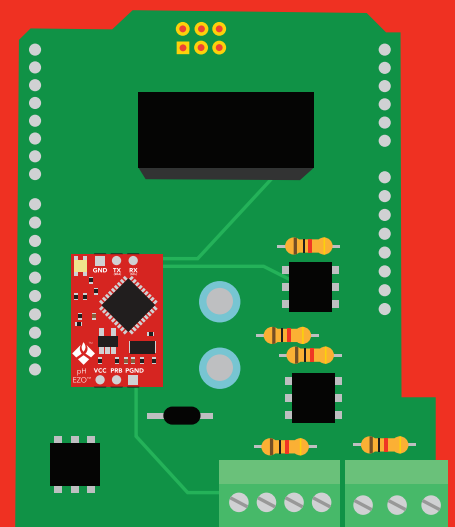

*Only after you are familiar
with EZO™ circuits operation

NEVER EXTEND THE CABLE
WITH CHEAP JUMPER WIRES!

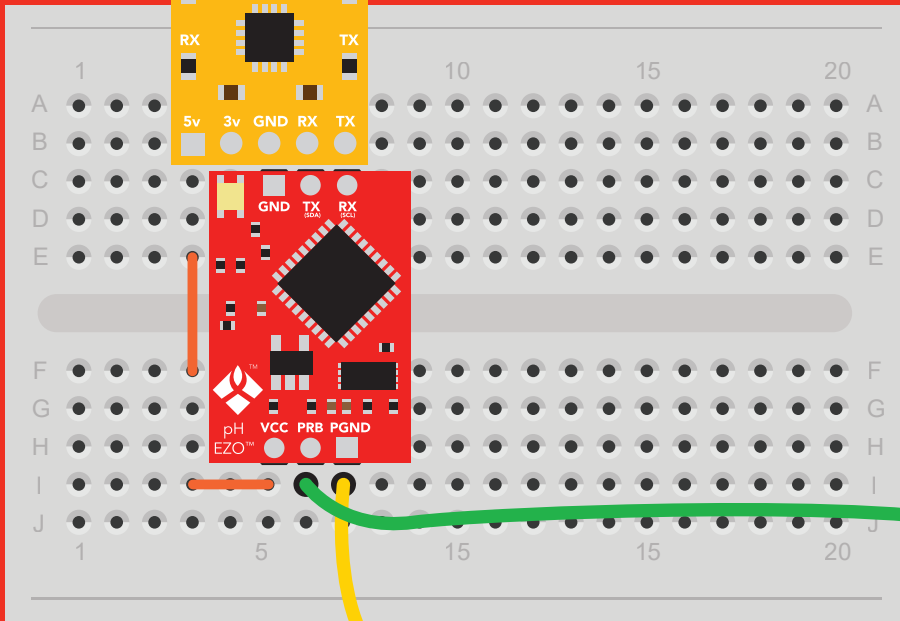

**DO NOT CUT THE PROBE CABLE
WITHOUT REFERRING TO **THIS DOCUMENT!****

**DO NOT MAKE YOUR OWN
UNSHIELDED CABLES!**

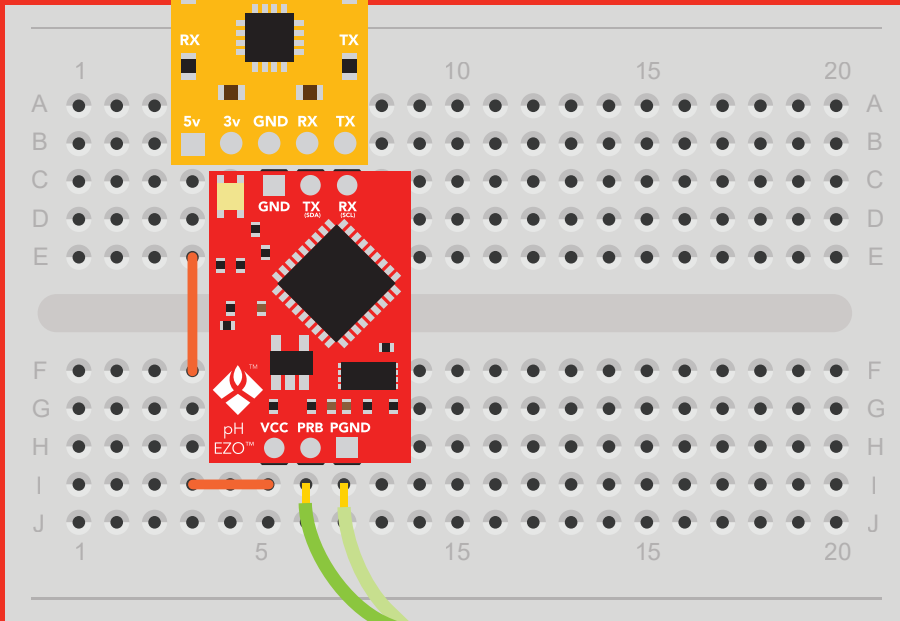

**ONLY USE SHIELDED CABLES.
REFER TO **THIS DOCUMENT!****

✓ Available data protocols

UART

Default

I²C

✗ Unavailable data protocols

SPI

Analog

RS-485

Mod Bus

4–20mA

UART mode

Settings that are retained if power is cut

- Baud rate
- Calibration
- Continuous mode
- Device name
- Enable/disable response codes
- Hardware switch to I²C mode
- LED control
- Protocol lock
- Software switch to I²C mode

Settings that are **NOT** retained if power is cut

- Find
- Sleep mode

UART mode

8 data bits no parity
1 stop bit no flow control

Baud 300
1,200
2,400
9,600 default
19,200
38,400
57,600
115,200

RX
Data in



TX
Data out



Vcc 3.3V – 5.5V

0V  VCC
0V

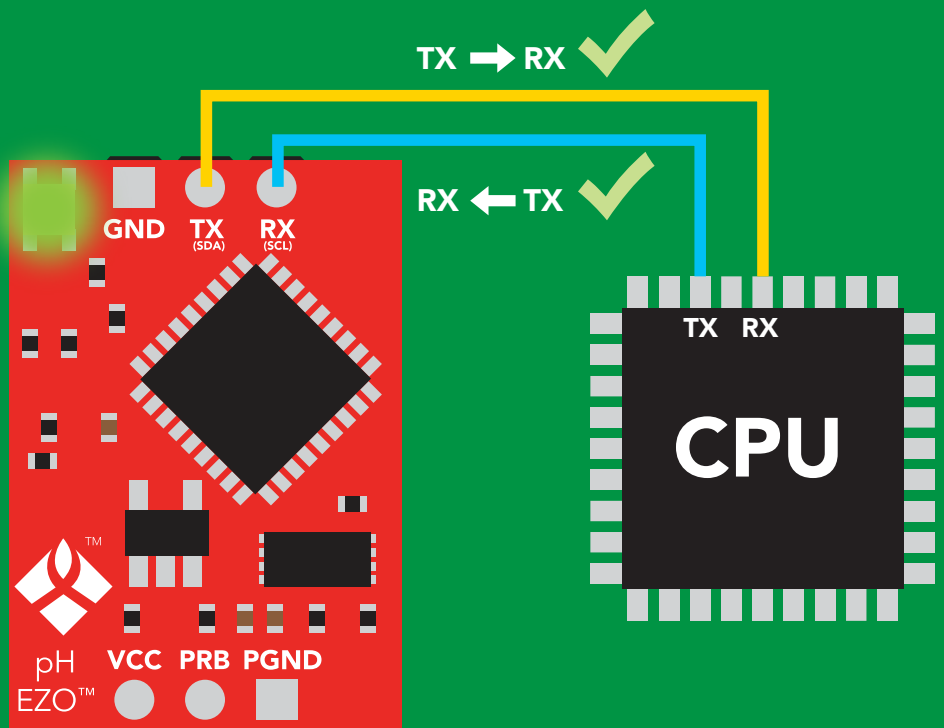

Data format

Reading	pH	Data type	floating point
Units	pH	Decimal places	3
Encoding	ASCII	Smallest string	4 characters
Format	string	Largest string	40 characters
Terminator	carriage return		

Default state

Mode	UART
Baud	9,600
Readings	continuous
Speed	1 reading per second
LED	on

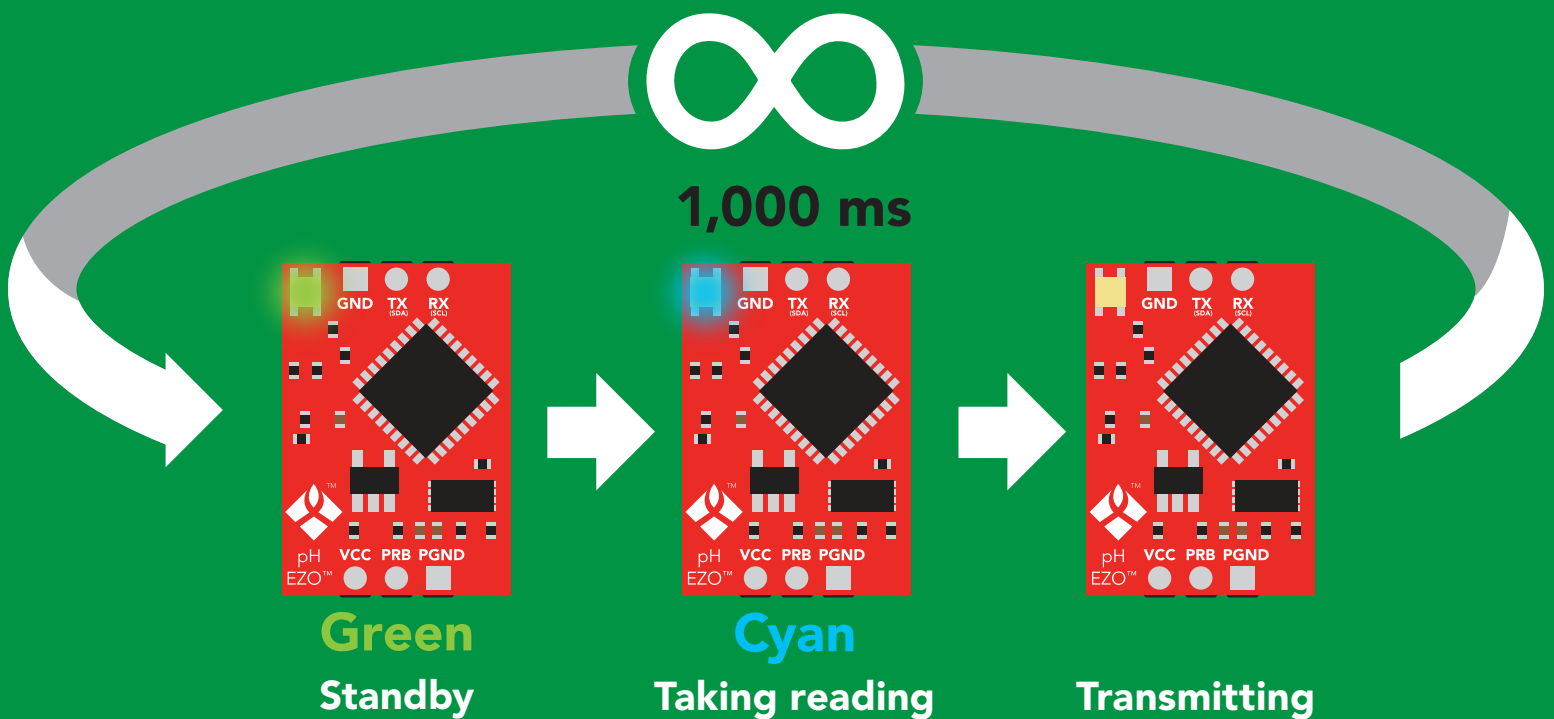

Receiving data from device

2 parts

ASCII data string

Command

Carriage return <cr>

Terminator

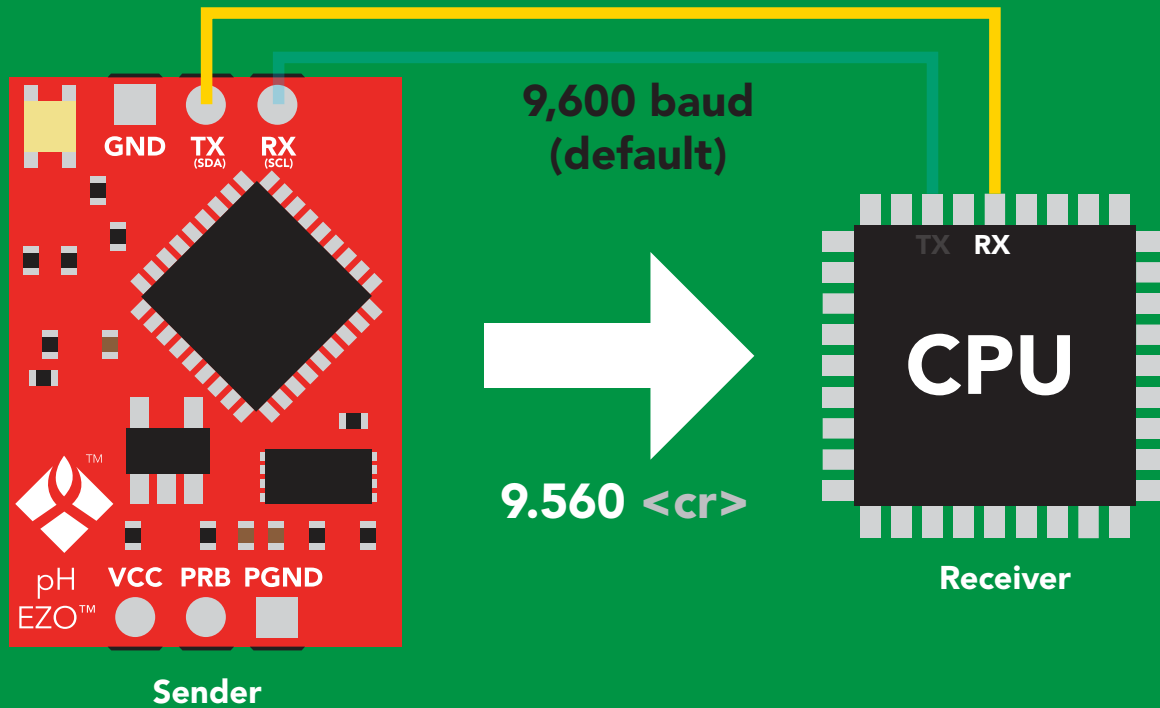

Advanced

ASCII: 9 . 5 6 0 <cr>

Hex: 39 2E 35 36 30 0D

Dec: 57 46 53 54 48 13

Sending commands to device

2 parts

Command (not case sensitive)

ASCII data string

Carriage return <cr>

Terminator

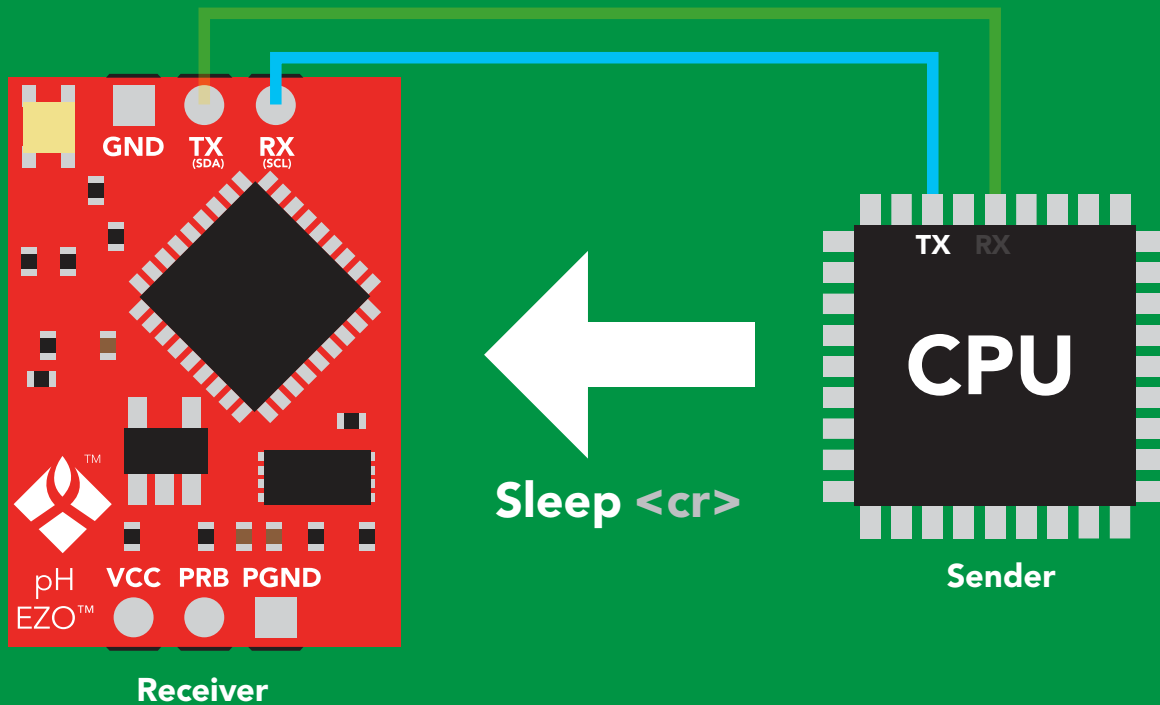

Advanced

ASCII: **S** **I** **e** **e** **p** **<cr>**

Hex: **53** **6C** **65** **65** **70** **0D**

Dec: **83** **108** **101** **101** **112** **13**

LED color definition

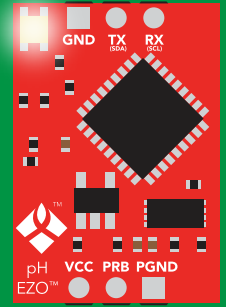
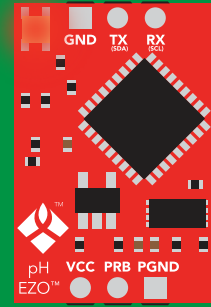
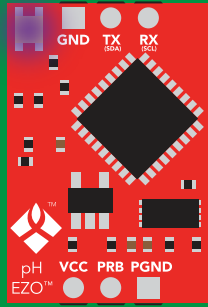
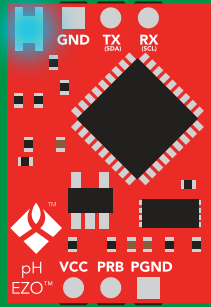
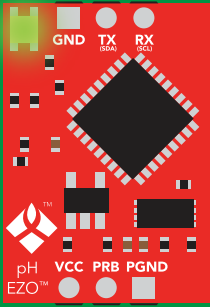

Green

UART standby

Cyan

Taking reading

Purple

Changing
baud rate

Red

Command
not understood

White

Find

5V

LED ON
+2.2 mA

3.3V

+0.6 mA

UART mode

command quick reference

All commands are ASCII strings or single ASCII characters.

Command	Function		Default state
Baud	change baud rate	pg. 35	9,600
C	enable/disable continuous reading	pg. 24	enabled
Cal	performs calibration	pg. 26	n/a
Export/import	export/import calibration	pg. 27	n/a
Factory	enable factory reset	pg. 37	n/a
Find	finds device with blinking white LED	pg. 23	n/a
i	device information	pg. 31	n/a
I2C	change to I ² C mode	pg. 38	not set
L	enable/disable LED	pg. 22	enabled
Name	set/show name of device	pg. 30	not set
Plock	enable/disable protocol lock	pg. 36	disabled
R	returns a single reading	pg. 25	n/a
Sleep	enter sleep mode/low power	pg. 34	n/a
Slope	returns the slope of the pH probe	pg. 28	n/a
Status	retrieve status information	pg. 33	enable
T	temperature compensation	pg. 29	25°C
*OK	enable/disable response codes	pg. 32	enable

LED control

Command syntax

L,1 <cr> LED on **default**

L,0 <cr> LED off

L,? <cr> LED state on/off?

Example

Response

L,1 <cr>

*OK <cr>

L,0 <cr>

*OK <cr>

L,? <cr>

?L,1 <cr> or ?L,0 <cr>

*OK <cr>

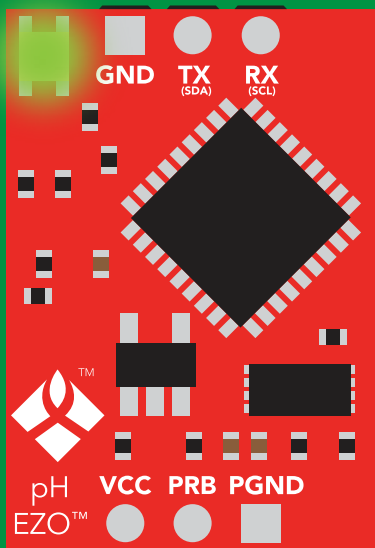

L,1

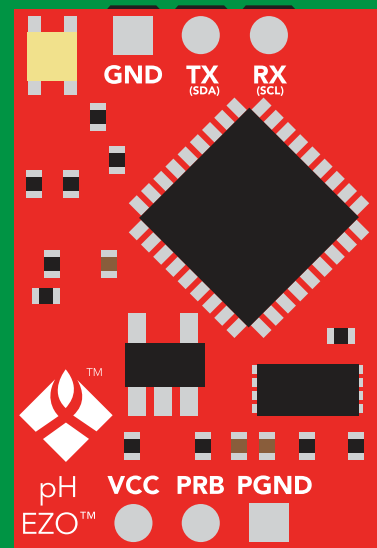

L,0

Find

Command syntax

This command will disable continuous mode
Send any character or command to terminate find.

Find <cr> LED rapidly blinks white, used to help find device*

*This command is only available for
firmware version 2.10 and above.

Example

Response

Find <cr>

*OK <cr>

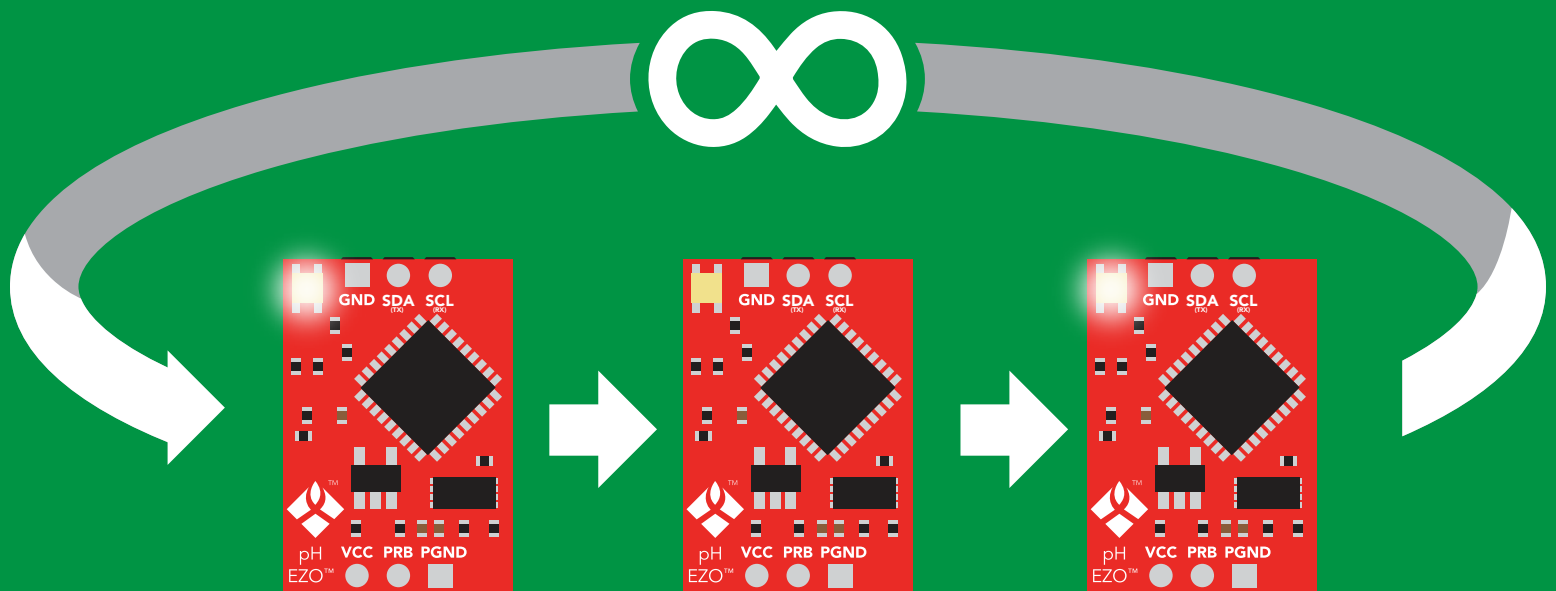

Continuous reading mode

Command syntax

- C,1 <cr>** enable continuous readings once per second **default**
- C,n <cr>** continuous readings every n seconds (n = 2 to 99 sec)*
- C,0 <cr>** disable continuous readings
- C,? <cr>** continuous reading mode on/off?

*This command is only available for firmware version 2.10 and above.

Example

Response

C,1 <cr>

***OK <cr>**
pH (1 sec) <cr>
pH (2 sec) <cr>
pH (n sec) <cr>

C,30 <cr>

***OK <cr>**
pH (30 sec) <cr>
pH (60 sec) <cr>
pH (90 sec) <cr>

C,0 <cr>

***OK <cr>**

C,? <cr>

?C,1 <cr> or ?C,0 <cr> or ?C,30 <cr>
***OK <cr>**

Single reading mode

Command syntax

R <cr> takes single reading

Example

R <cr>

Response

9.560 <cr>
***OK** <cr>

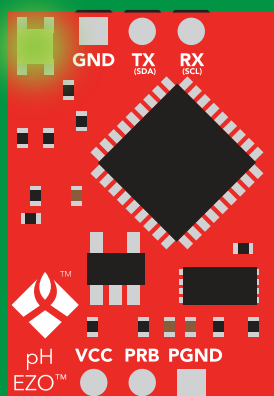

Green
Standby

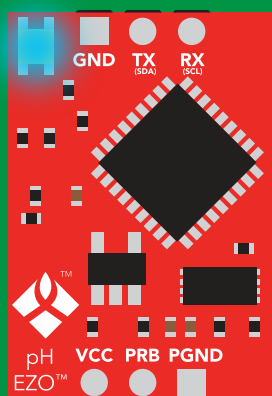

Cyan
Taking reading

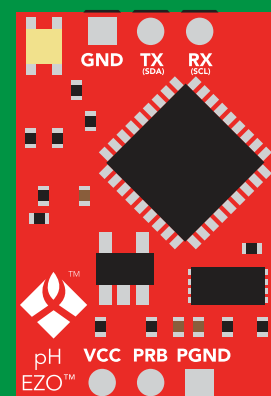
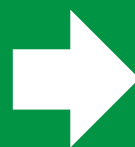

Transmitting



800 ms

Calibration

Command syntax

Issuing the cal,mid command after the EZO™ pH circuit has been calibrated, will clear the other calibration points. Full calibration will have to be redone.

Cal,mid,n <cr> single point calibration at midpoint
Cal,low,n <cr> two point calibration at lowpoint
Cal,high,n <cr> three point calibration at highpoint
Cal,clear <cr> delete calibration data
Cal,? <cr> device calibrated?

Example

Response

Cal,mid,7.00 <cr>

***OK** <cr>

Cal,low,4.00 <cr>

***OK** <cr>

Cal,high,10.00 <cr>

***OK** <cr>

Cal,clear <cr>

***OK** <cr>

Cal,? <cr>

?Cal,0 <cr> or **?Cal,1** <cr> or
one point
?Cal,2 <cr> or **?Cal,3** <cr>
two point three point
***OK** <cr>

Export/import calibration

Command syntax

Export: Use this command to save calibration settings
Import: Use this command to load calibration settings to one or more devices.

Export <cr> export calibration string from calibrated device*
Import <cr> import calibration string to new device*
Export,? <cr> calibration string info*

*This command is only available for firmware version 2.10 and above.

Example

Response

Export,? <cr>

10,120 <cr>

Response breakdown

10, 120

↑ ↑
of strings to export # of bytes to export

Export strings can be up to 12 characters long, and is always followed by <cr>

Export <cr>

59 6F 75 20 61 72 <cr> (1 of 10)

Export <cr>

65 20 61 20 63 6F <cr> (2 of 10)

(7 more)

⋮

Export <cr>

6F 6C 20 67 75 79 <cr> (10 of 10)

Export <cr>

***DONE**

Disabling *OK simplifies this process

Import, n
(FIFO)

Import, 59 6F 75 20 61 72 <cr> (1 of 10)

Slope

Command syntax

After calibrating a pH probe issuing the slope command will show how closely (in percentage) the calibrated pH probe is working compared to the "ideal" pH probe.

`Slope,? <cr>` returns the slope of the pH probe

Example

```
Slope,? <cr>
```

Response

```
?Slope,99.7,100.3 <cr>  
*OK <cr>
```

Response breakdown

?Slope,

99.7,

100.3

99.7% is how closely the slope of the **acid** calibration line matched the "ideal" pH probe.

100.3% is how closely the slope of the **base** calibration matches the "ideal" pH probe.

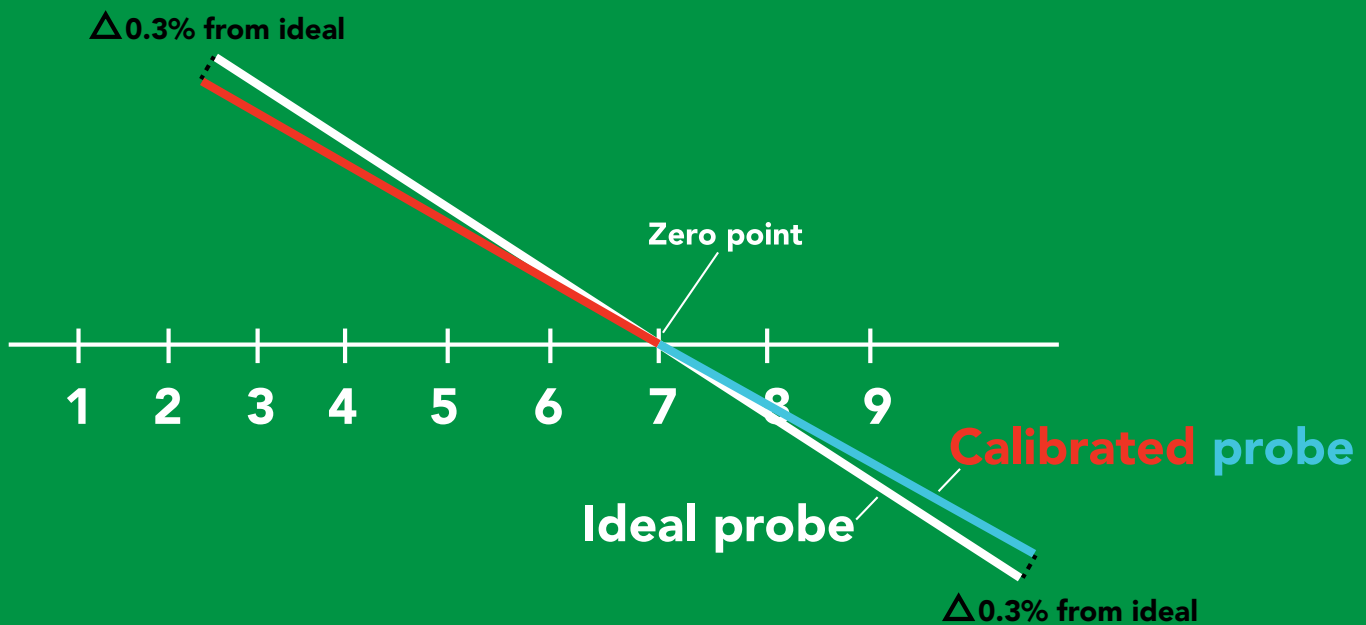

Temperature compensation

Command syntax

Temperature is always in Celsius

T,n <cr> n = any value; floating point or int

T,? <cr> compensated temperature value?

Example

T,19.5 <cr>

Response

*OK <cr>

T,? <cr>

?T,19.5 <cr>

*OK <cr>

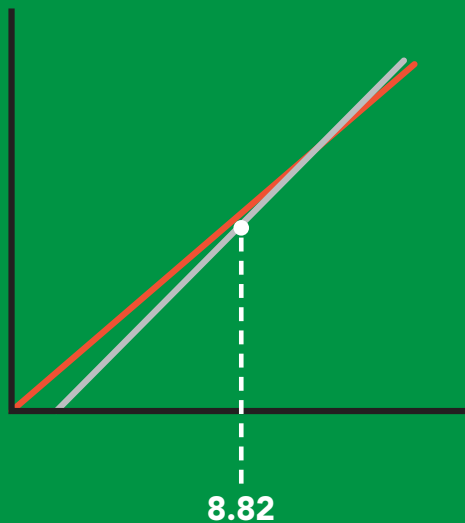

→
T,19.5 <cr>

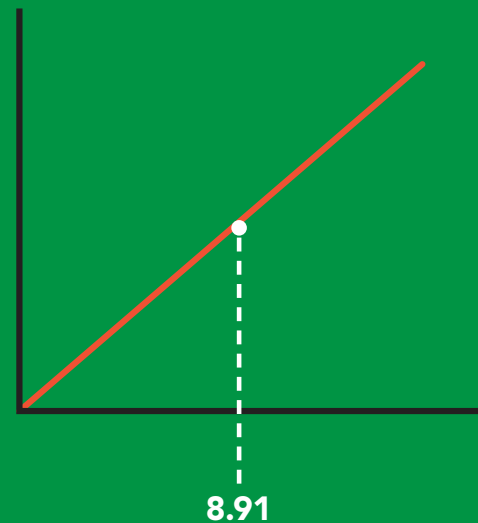

Naming device

Command syntax

Name,n <cr> set name

Name,? <cr> show name

n =

1 2 3 4 5 6 7 8 9 10 11 12 13 14 15 16

Up to 16 ASCII characters

Example

Name,zzt <cr>

Response

*OK <cr>

Name,? <cr>

?Name,zzt <cr>

*OK <cr>

Name,zzt

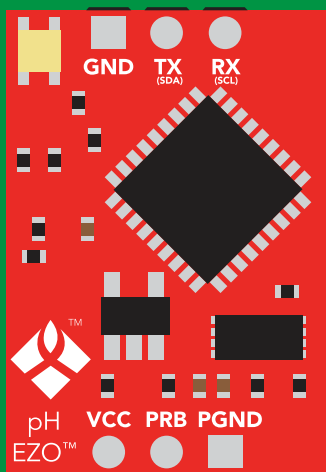

*OK <cr>

Name,?

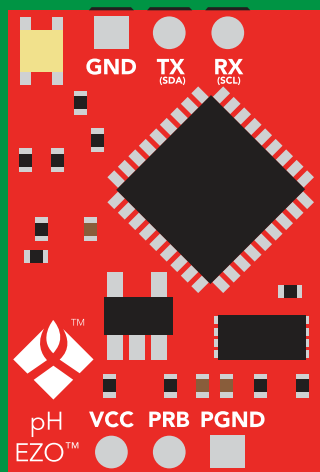

Name,zzt <cr>

*OK <cr>

Device information

Command syntax

```
i <cr> device information
```

Example

```
i <cr>
```

Response

```
?i,pH,1.98 <cr>  
*OK <cr>
```

Response breakdown

?i,	pH,	1.98
	↑	↑
	Device	Firmware

Response codes

Command syntax

- *OK,1** <cr> enable response **default**
- *OK,0** <cr> disable response
- *OK,?** <cr> response on/off?

Example

Response

R <cr>

9.560 <cr>
***OK** <cr>

***OK,0** <cr>

no response, ***OK** disabled

R <cr>

9.560 <cr> ***OK** disabled

***OK,?** <cr>

?*OK,1 <cr> or **?*OK,0** <cr>

Other response codes

- *ER** unknown command
- *OV** over volt ($VCC \geq 5.5V$)
- *UV** under volt ($VCC \leq 3.1V$)
- *RS** reset
- *RE** boot up complete, ready
- *SL** entering sleep mode
- *WA** wake up

These response codes cannot be disabled

Reading device status

Command syntax

Status <cr> voltage at Vcc pin and reason for last restart

Example

```
Status <cr>
```

Response

```
?Status,P,5.038 <cr>  
*OK <cr>
```

Response breakdown

```
?Status, P, 5.038  
          ↑      ↑  
          Reason for restart Voltage at Vcc
```

Restart codes

P	powered off
S	software reset
B	brown out
W	watchdog
U	unknown

Sleep mode/low power

Command syntax

Send any character or command to awaken device.

Sleep <cr> enter sleep mode/low power

Example

Response

Sleep <cr>

*SL

Any command

*WA <cr> wakes up device

5V	STANDBY 16 mA	SLEEP 1.16 mA
3.3V	13.9 mA	0.995 mA

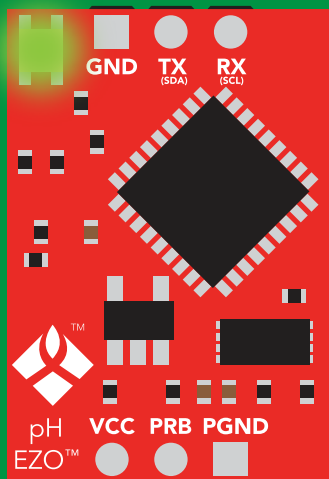

Standby
16 mA

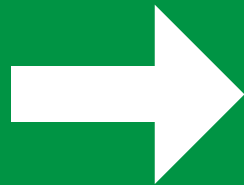

Sleep <cr>

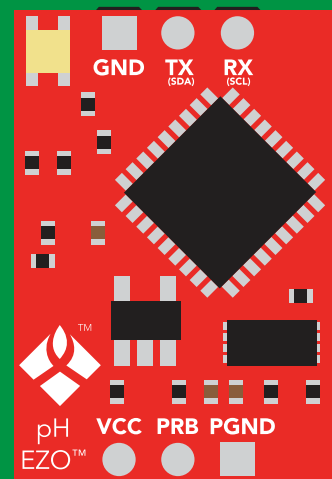

Sleep
1.16 mA

Change baud rate

Command syntax

Baud,n <cr> change baud rate

Example

Baud,38400 <cr>

Response

*OK <cr>

Baud,? <cr>

?Baud,38400 <cr>

*OK <cr>

n =

- 300
- 1200
- 2400
- 9600 default**
- 19200
- 38400
- 57600
- 115200

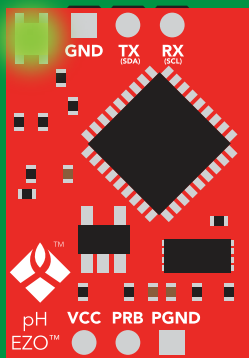

Standby

Baud,38400 <cr>

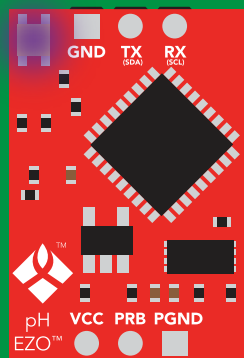

Changing
baud rate

*OK <cr>

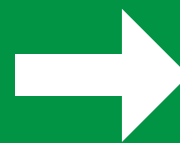

(reboot)

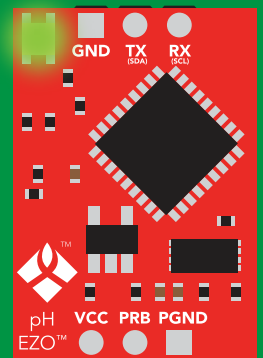

Standby

Protocol lock

Command syntax

Locks device to UART mode.

Plock,1 <cr> enable Plock

Plock,0 <cr> disable Plock **default**

Plock,? <cr> Plock on/off?

Example

Response

Plock,1 <cr>

*OK <cr>

Plock,0 <cr>

*OK <cr>

Plock,? <cr>

?Plock,1 <cr> or ?Plock,0 <cr>

Plock,1

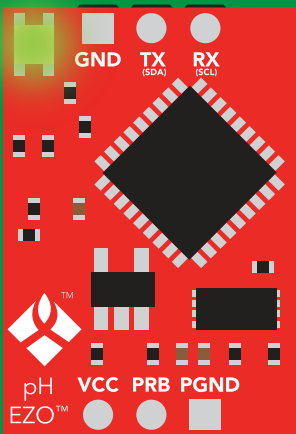

*OK <cr>

I2C,100

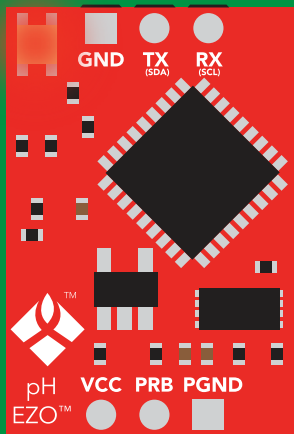

cannot change to I²C

*ER <cr>

Short

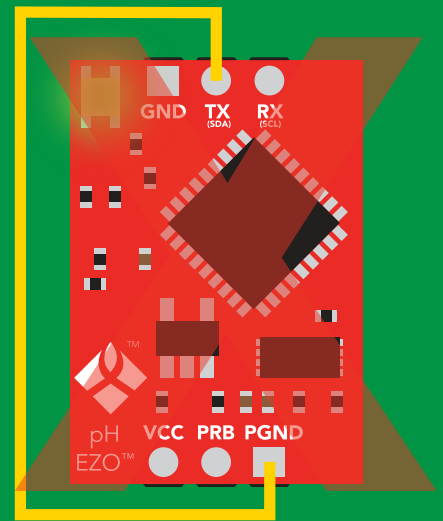

cannot change to I²C

Factory reset

Command syntax

Clears calibration
LED on
"*OK" enabled

Factory <cr> enable factory reset

Example

Response

Factory <cr>

*OK <cr>

Factory <cr>

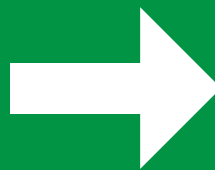
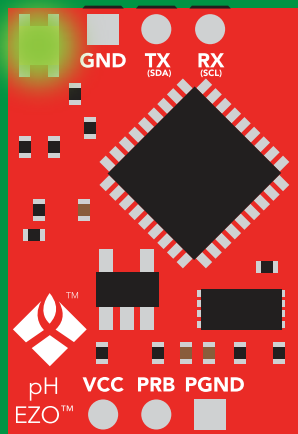

(reboot)

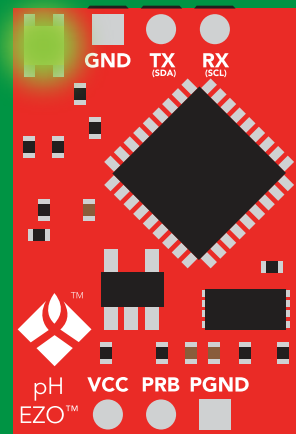

*OK <cr>

*RS <cr>

*RE <cr>

Baud rate will not change

Change to I²C mode

Command syntax

Default I²C address 99 (0x63)

I2C,n <cr> sets I²C address and reboots into I²C mode

n = any number 1 – 127

Example

Response

I2C,100 <cr>

*OK (reboot in I²C mode)

Wrong example

Response

I2C,139 <cr> n ≠ 127

*ER <cr>

I2C,100

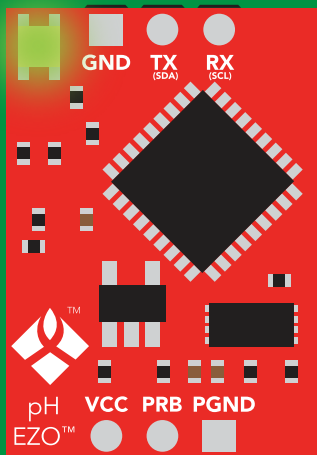

Green
*OK <cr>

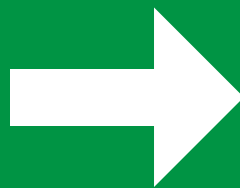

(reboot)

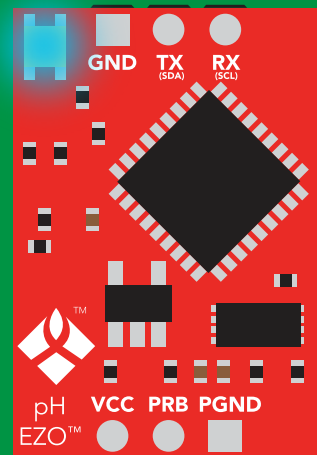

Blue
now in I²C mode

Manual switching to I²C

- Make sure Plock is set to 0
- Disconnect ground (power off)
- Disconnect TX and RX
- Connect TX to PGND
- Confirm RX is disconnected
- Connect ground (power on)
- Wait for LED to change from Green to Blue
- Disconnect ground (power off)
- Reconnect all data and power

Manually switching to I²C will set the I²C address to 99 (0x63)

Example

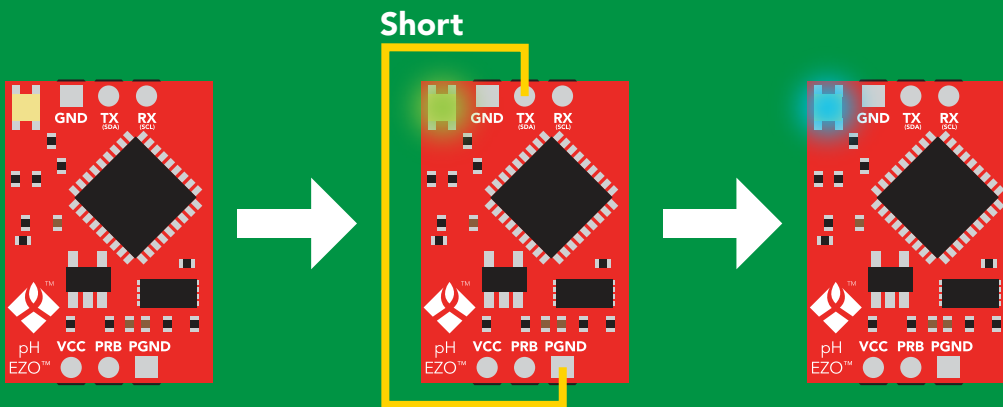

Wrong Example

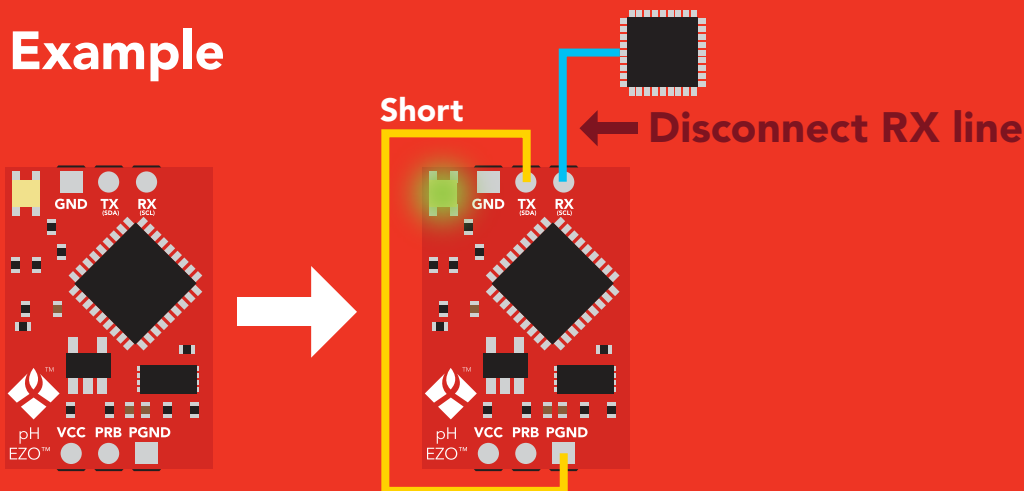

I²C mode

The I²C protocol is **considerably more complex** than the UART (RS-232) protocol. Atlas Scientific assumes the embedded systems engineer understands this protocol.

To set your EZO™ device into I²C mode click [here](#)

Settings that are retained if power is cut

- Calibration
- Change I²C address
- Hardware switch to UART mode
- LED control
- Protocol lock
- Software switch to UART mode

Settings that are **NOT** retained if power is cut

- Find
- Sleep mode

I²C mode

I²C address (0x01 – 0x7F)
99 (0x63) default

Vcc 3.3V – 5.5V

Clock speed 100 – 400 kHz

SDA 

SCL 



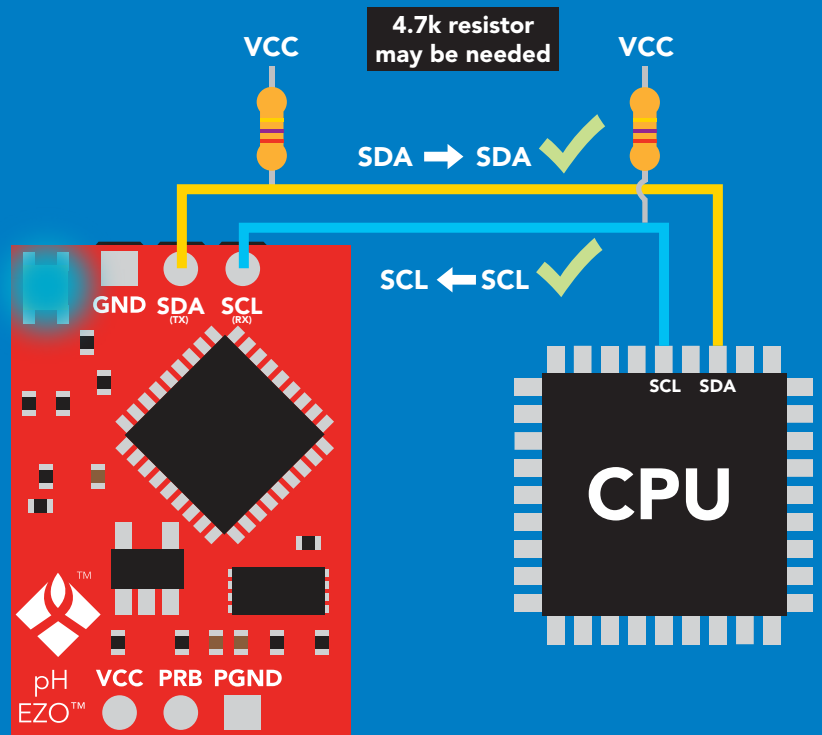

Data format

Reading	pH	Data type	floating point
Units	pH	Decimal places	3
Encoding	ASCII	Smallest string	4 characters
Format	string	Largest string	399 characters

Sending commands to device

5 parts



Example

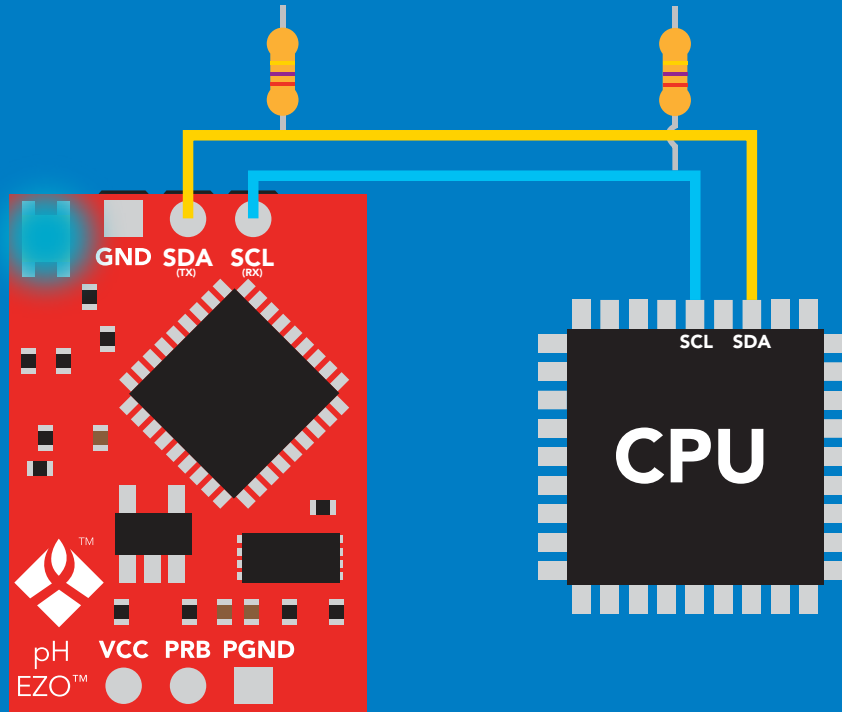

Advanced

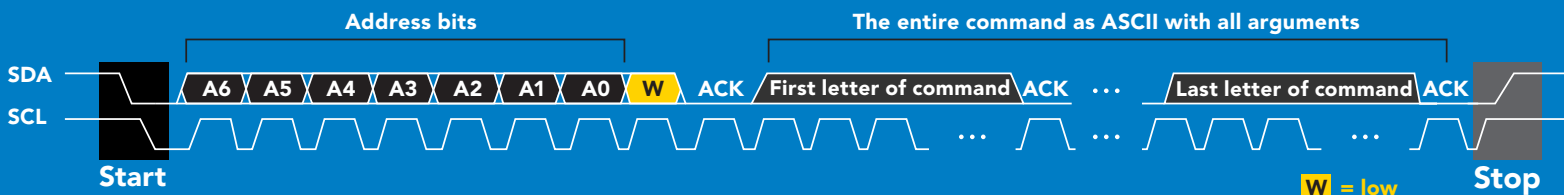

Requesting data from device

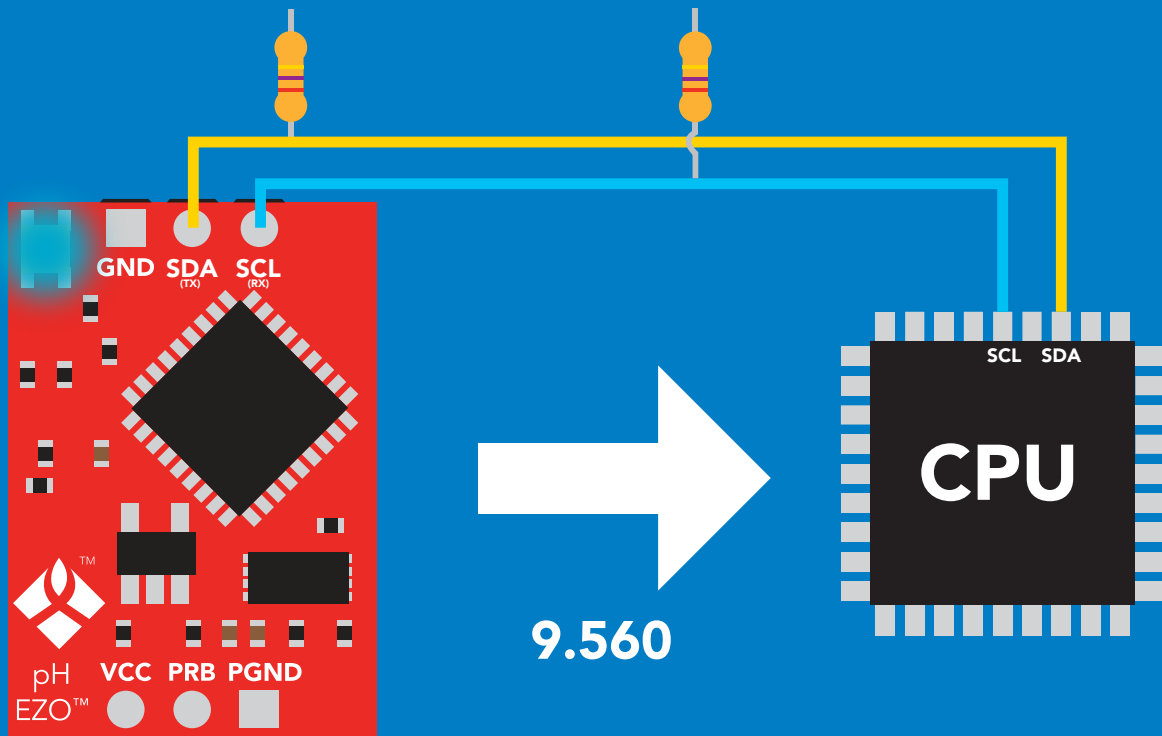
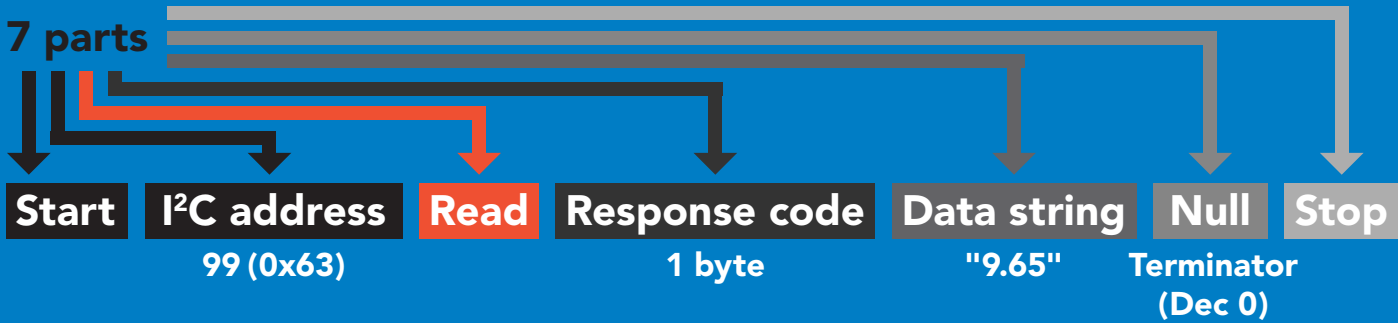

Advanced

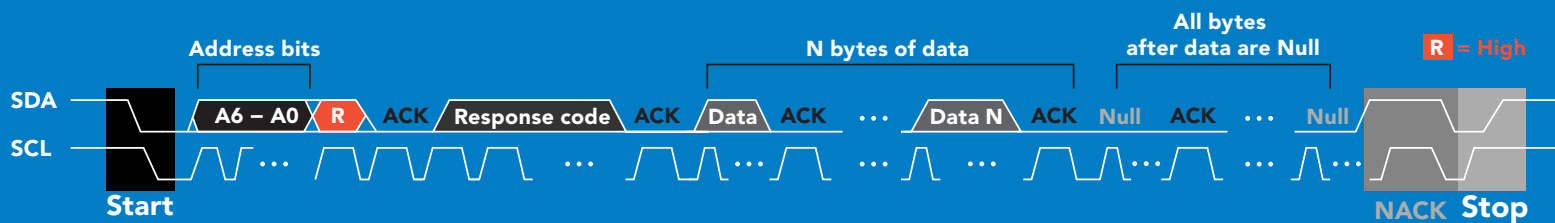

Response codes

After a command has been issued, a 1 byte response code can be read in order to confirm that the command was processed successfully.

Reading back the response code is completely optional, and is not required for normal operation.

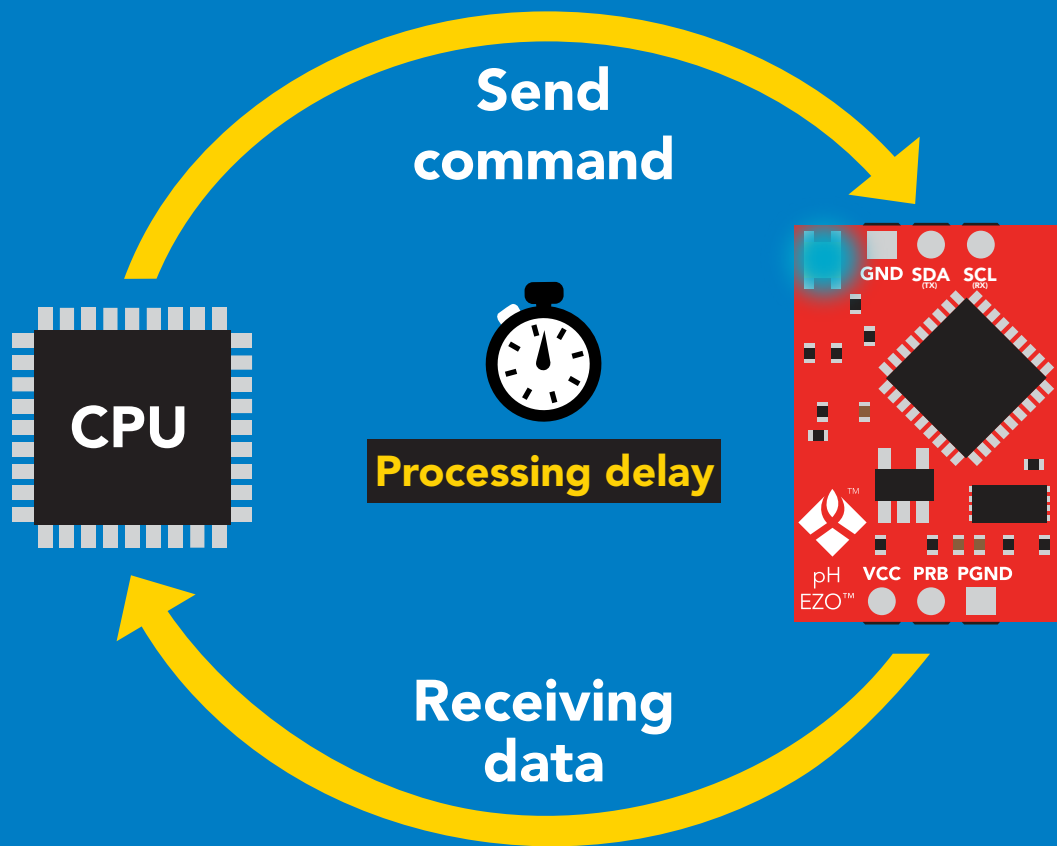

Example

```
I2C_start;  
I2C_address;  
I2C_write(EZO_command);  
I2C_stop;
```

```
delay(300);
```



Processing delay

```
I2C_start;  
I2C_address;  
Char[ ] = I2C_read;  
I2C_stop;
```

If there is no processing delay or the processing delay is too short, the response code will always be 254.

Response codes

Single byte, not string

255	no data to send
254	still processing, not ready
2	syntax error
1	successful request

LED color definition

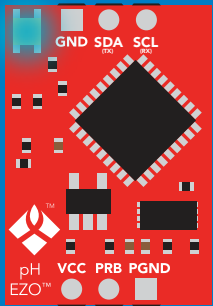

Blue

I²C standby

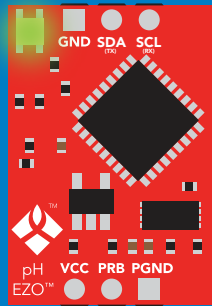

Green

Taking reading

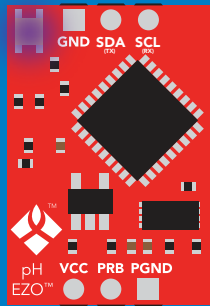

Purple

Changing
I²C ID#

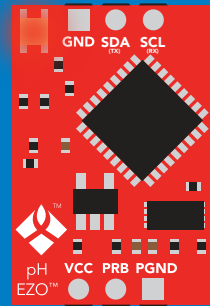

Red

Command
not understood

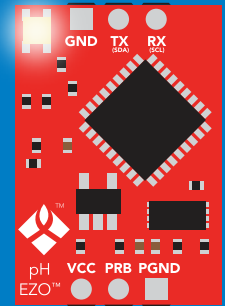

White

Find

5V

LED ON

+2.2 mA

3.3V

+0.6 mA

I²C mode

command quick reference

All commands are ASCII strings or single ASCII characters.

Command	Function	
Baud	switch back to UART mode	pg. 60
Cal	performs calibration	pg. 50
Export/import	export/import calibration	pg. 51
Factory	enable factory reset	pg. 59
Find	finds device with blinking white LED	pg. 48
i	device information	pg. 54
I2C	change I ² C address	pg. 58
L	enable/disable LED	pg. 47
Plock	enable/disable protocol lock	pg. 57
R	returns a single reading	pg. 49
Sleep	enter sleep mode/low power	pg. 56
Slope	returns the slope of the pH probe	pg. 52
Status	retrieve status information	pg. 55
T	temperature compensation	pg. 53

LED control

Command syntax

300ms  processing delay

L,1 LED on **default**

L,0 LED off

L,? LED state on/off?

Example

Response

L,1



Wait 300ms **1** **0**
Dec Null

L,0

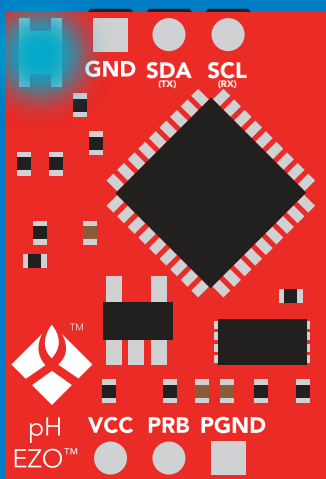

Wait 300ms **1** **0**
Dec Null

L,?

Wait 300ms **1** **?L,1** **0** or **1** **?L,0** **0**
Dec ASCII Null Dec ASCII Null

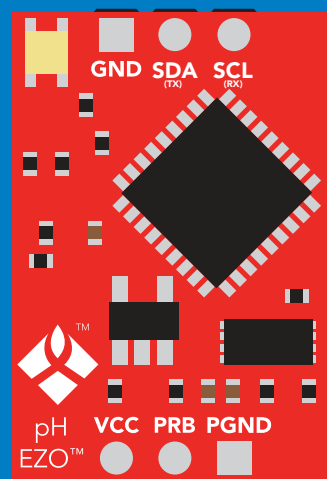

L,1



L,0

Find

300ms  processing delay

Command syntax

This command will disable continuous mode
Send any character or command to terminate find.

Find <cr> LED rapidly blinks white, used to help find device*

*This command is only available for
firmware version 2.10 and above.

Example

Find <cr>

Response

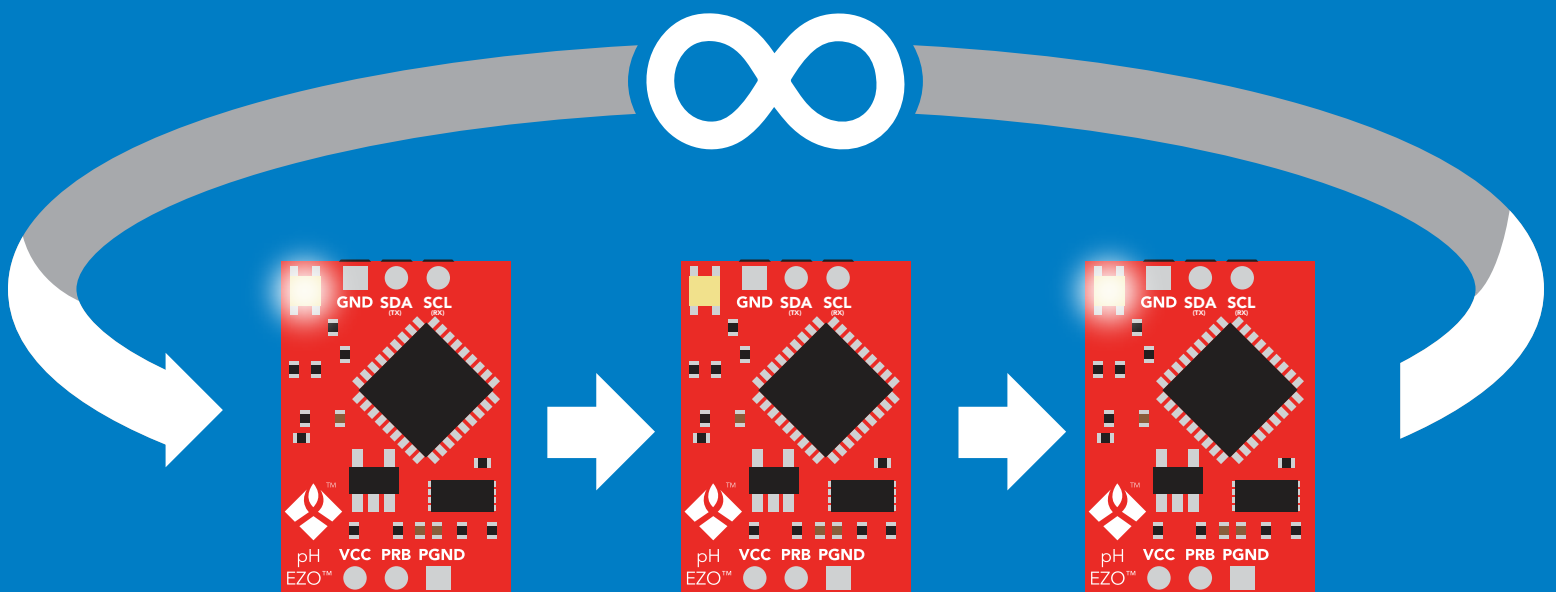

Taking reading

Command syntax

900ms  processing delay

R return 1 reading

Example

Response

R  **1** **9.560** **0**
Wait 900ms Dec ASCII Null

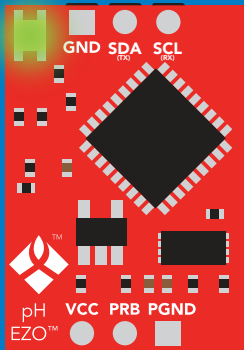

Green

Taking reading

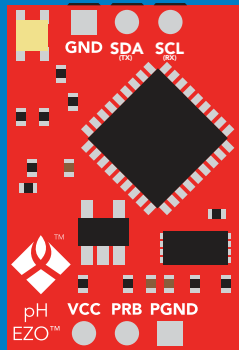
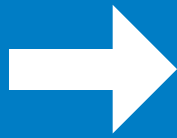

Transmitting

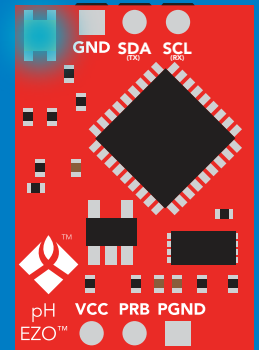
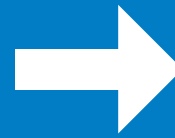

Blue

Standby

Calibration

300ms  processing delay

Issuing the cal,mid command after the EZO™ pH circuit has been calibrated, will clear the other calibration points. Full calibration will have to be redone.

Command syntax

Cal,mid,n	single point calibration at midpoint
Cal,low,n	two point calibration at lowpoint
Cal,high,n	three point calibration at highpoint
Cal,clear	delete calibration data
Cal,?	device calibrated?

Example

Response

Cal,mid,7.00

 Wait 900ms

1	0
Dec	Null

Cal,low,4.00

 Wait 900ms

1	0
Dec	Null

Cal,high,10.00

 Wait 900ms

1	0
Dec	Null

Cal,clear

 Wait 300ms

1	0
Dec	Null

Cal,?

 Wait 300ms

1	?Cal,0	0	or	1	?Cal,1	0
Dec	ASCII	Null		Dec	ASCII	Null
					one point	
1	?Cal,2	0	or	1	?Cal,3	0
Dec	ASCII	Null		Dec	ASCII	Null
	two point				three point	

Export/import calibration

Command syntax

Export: Use this command to save calibration settings
Import: Use this command to load calibration settings to one or more devices.

Export export calibration string from calibrated device*
Import import calibration string to new device*
Export,? calibration string info*

300ms  processing delay

*This command is only available for firmware version 2.10 and above.

Example

Response

Export,?

 **1** **10,120** **0**
Wait 300ms Dec ASCII Null

Response breakdown

10, 120
↑ # of strings to export ↑ # of bytes to export

Export strings can be up to 12 characters long

Export

(8 more)

 **1** **59 6F 75 20 61 72** **0** (1 of 10)
Wait 300ms Dec ASCII Null

Export

 **1** **65 20 61 20 63 6F** **0** (10 of 10)
Wait 300ms Dec ASCII Null

Export

 **1** ***DONE** **0**
Wait 300ms Dec ASCII Null

Import, n
(FIFO)

Import, 59 6F 75 20 61 72 (1 of 10)
ASCII

Slope

300ms  processing delay

Command syntax

After calibrating a pH probe issuing the slope command will show how closely (in percentage) the calibrated pH probe is working compared to the "ideal" pH probe.

`Slope,?` returns the slope of the pH probe

Example

`Slope,?`

Response

Wait 300ms

1
Dec

?Slope,99.7,100.3
ASCII

0
Null

Response breakdown

`?Slope,`

`99.7,`

↑
99.7% is how closely the slope of the **acid** calibration line matched the "ideal" pH probe.

`100.3`

↑
100.3% is how closely the slope of the **base** calibration matches the "ideal" pH probe.

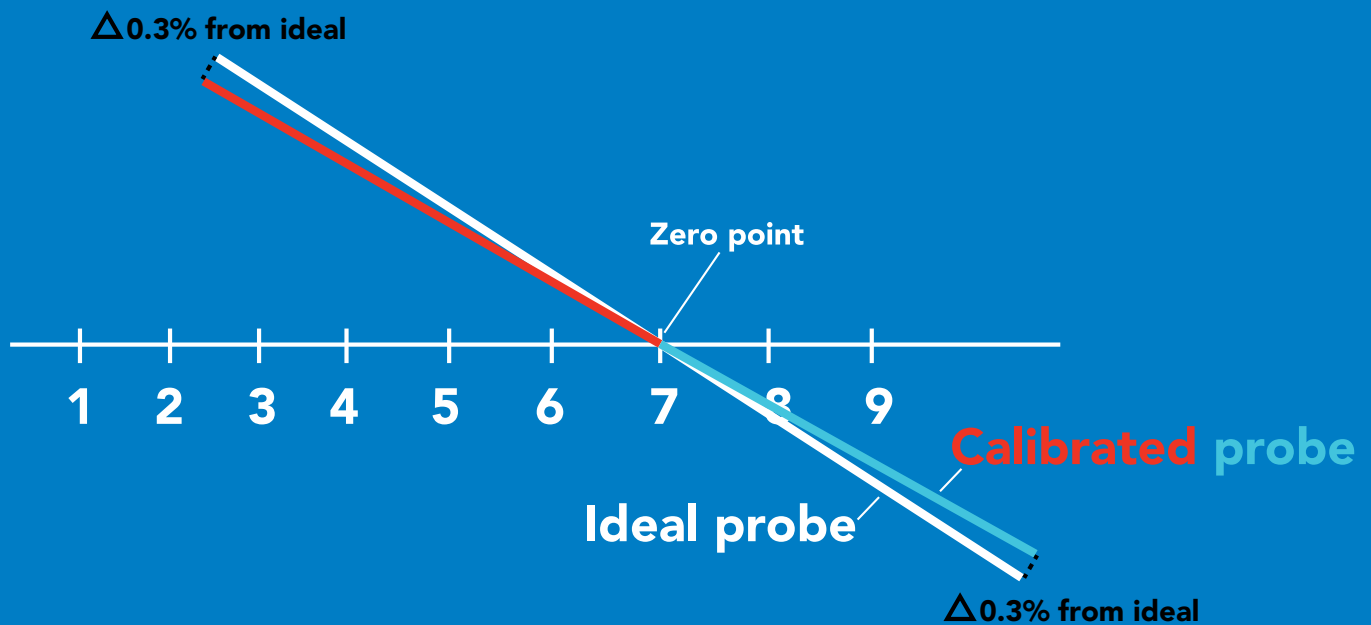

Temperature compensation

300ms  processing delay

Command syntax

Temperature is always in Celsius

T,n n = any value; floating point or int
T,? compensated temperature value?

Example

T,19.5

 Wait 300ms

1	0
Dec	Null

T,?

 Wait 300ms

1	?T,19.5	0
Dec	ASCII	Null

Response

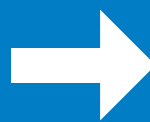
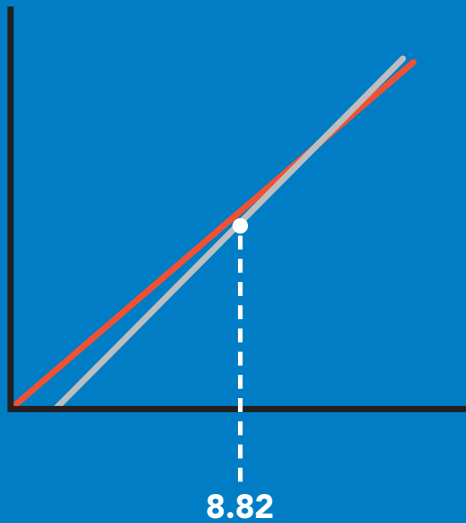

T,19.5

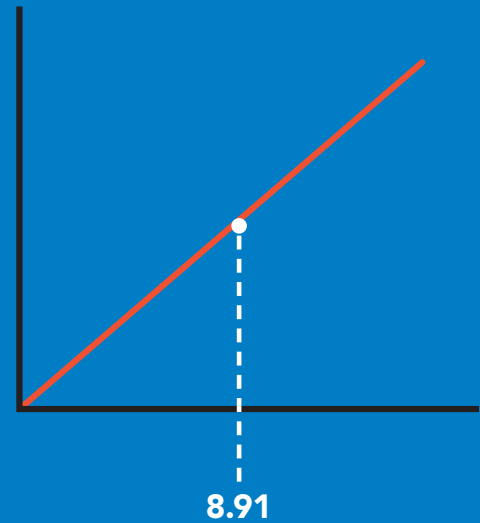

Device information

Command syntax

300ms  processing delay

i device information

Example

Response

i



Wait 300ms

1

Dec

?i,pH, 19.8

ASCII

0

Null

Response breakdown

?i,	pH,	1.98
	↑	↑
	Device	Firmware

Reading device status

Command syntax

300ms  processing delay

Status voltage at Vcc pin and reason for last restart

Example

Response

Status

 Wait 300ms	1 Dec	?Status,P,5.038 ASCII	0 Null
---	----------	--------------------------	-----------

Response breakdown

?Status,	P,	5.038
	↑ Reason for restart	↑ Voltage at Vcc

Restart codes

P	powered off
S	software reset
B	brown out
W	watchdog
U	unknown

Sleep mode/low power

Command syntax

Sleep enter sleep mode/low power

Send any character or command to awaken device.

Example

Response

Sleep

no response

Do not read status byte after issuing sleep command.

Any command

wakes up device

5V

STANDBY

16 mA

SLEEP

1.16 mA

3.3V

13.9 mA

0.995 mA

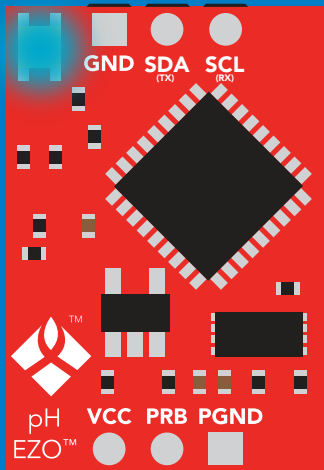

Standby

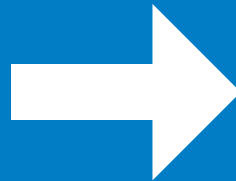

Sleep

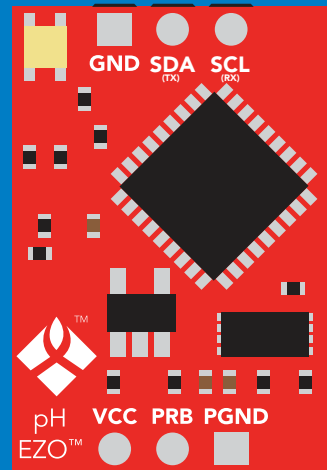

Sleep

Protocol lock

Command syntax

300ms  processing delay

Plock,1 enable Plock

Plock,0 disable Plock

Plock,? Plock on/off?

Locks device to I²C mode.

default

Example

Response

Plock,1

Wait 300ms

1	0
Dec	Null

Plock,0

Wait 300ms

1	0
Dec	Null

Plock,?

Wait 300ms

1	?Plock,1	0
Dec	ASCII	Null

Plock,1

Serial, 9600

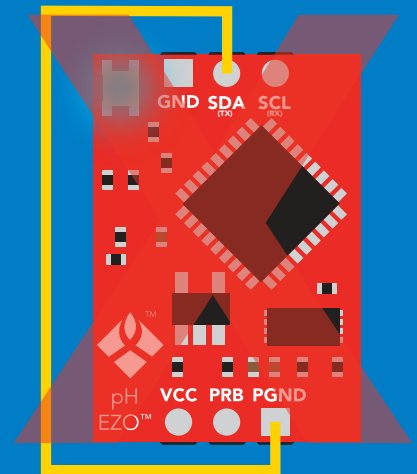
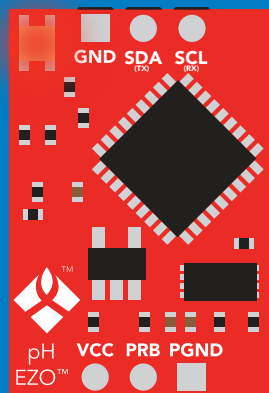
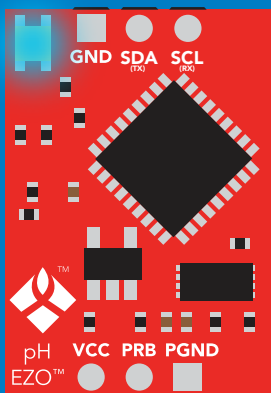

cannot change to UART

cannot change to UART

I²C address change

Command syntax

300ms  processing delay

I2C,n sets I²C address and reboots into I²C mode

Example

Response

I2C,100

device reboot

Warning!

Changing the I²C address will prevent communication between the circuit and the CPU, until the CPU is updated with the new I²C address.

Default I²C address is 99 (0x63).

n = any number 1 – 127

I2C,100

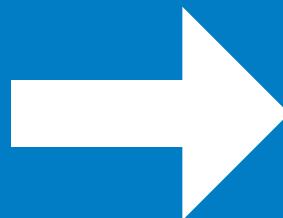
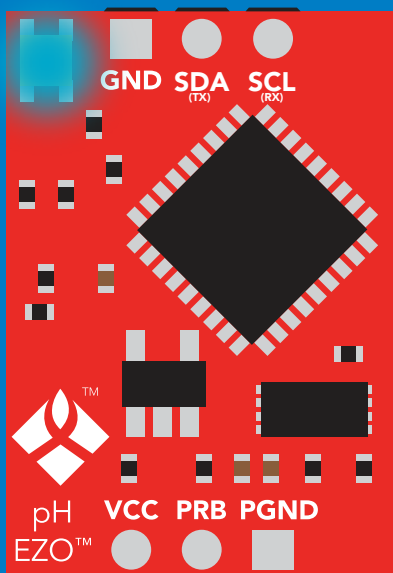

(reboot)

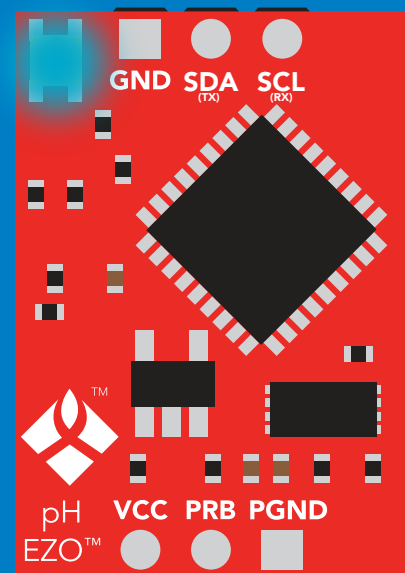

Factory reset

Command syntax

Factory reset will not take the device out of I²C mode.

Factory enable factory reset

I²C address will not change

Example

Response

Factory

device reboot

Clears calibration
LED on
Response codes enabled

Factory

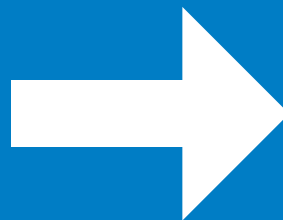
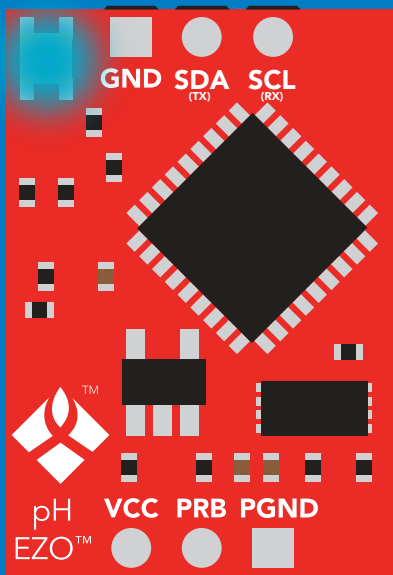

(reboot)

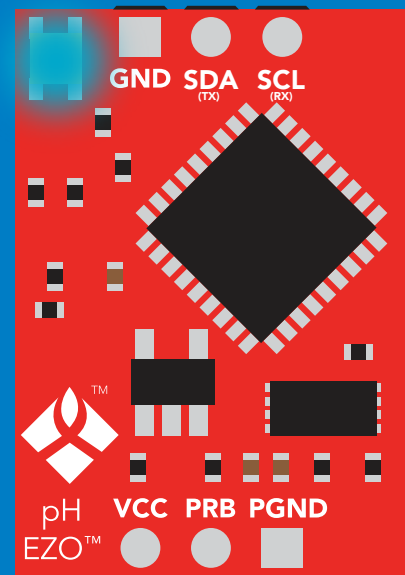

Change to UART mode

Command syntax

Baud,n switch from I²C to UART

Example

Baud,9600

Response

reboot in UART mode

n = [300
1200
2400
9600
19200
38400
57600
115200

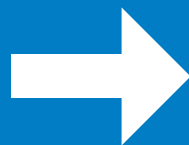
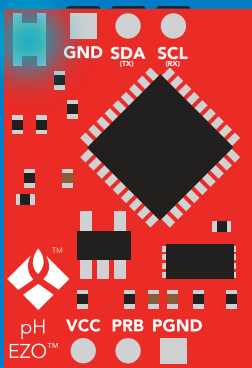

Serial,9600

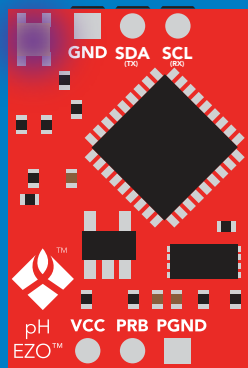

(reboot)

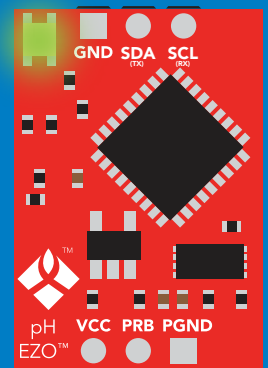

Changing to UART mode

Manual switching to UART

- Make sure Plock is set to 0
- Disconnect ground (power off)
- Disconnect TX and RX
- Connect TX to PGND
- Confirm RX is disconnected
- Connect ground (power on)
- Wait for LED to change from Blue to Green
- Disconnect ground (power off)
- Reconnect all data and power

Example

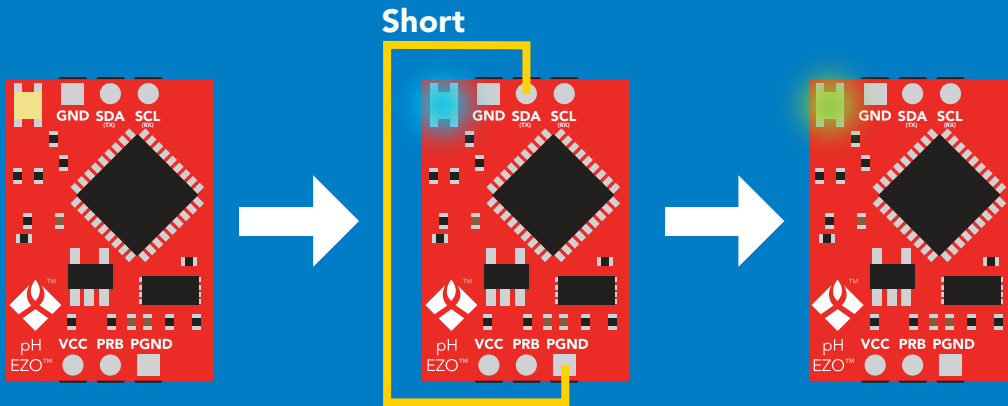

Wrong Example

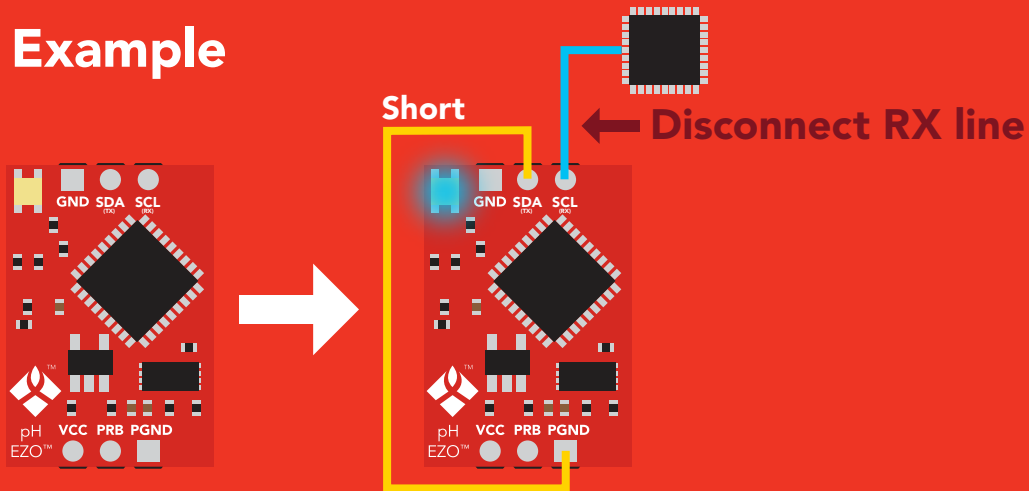

EZO™ circuit footprint

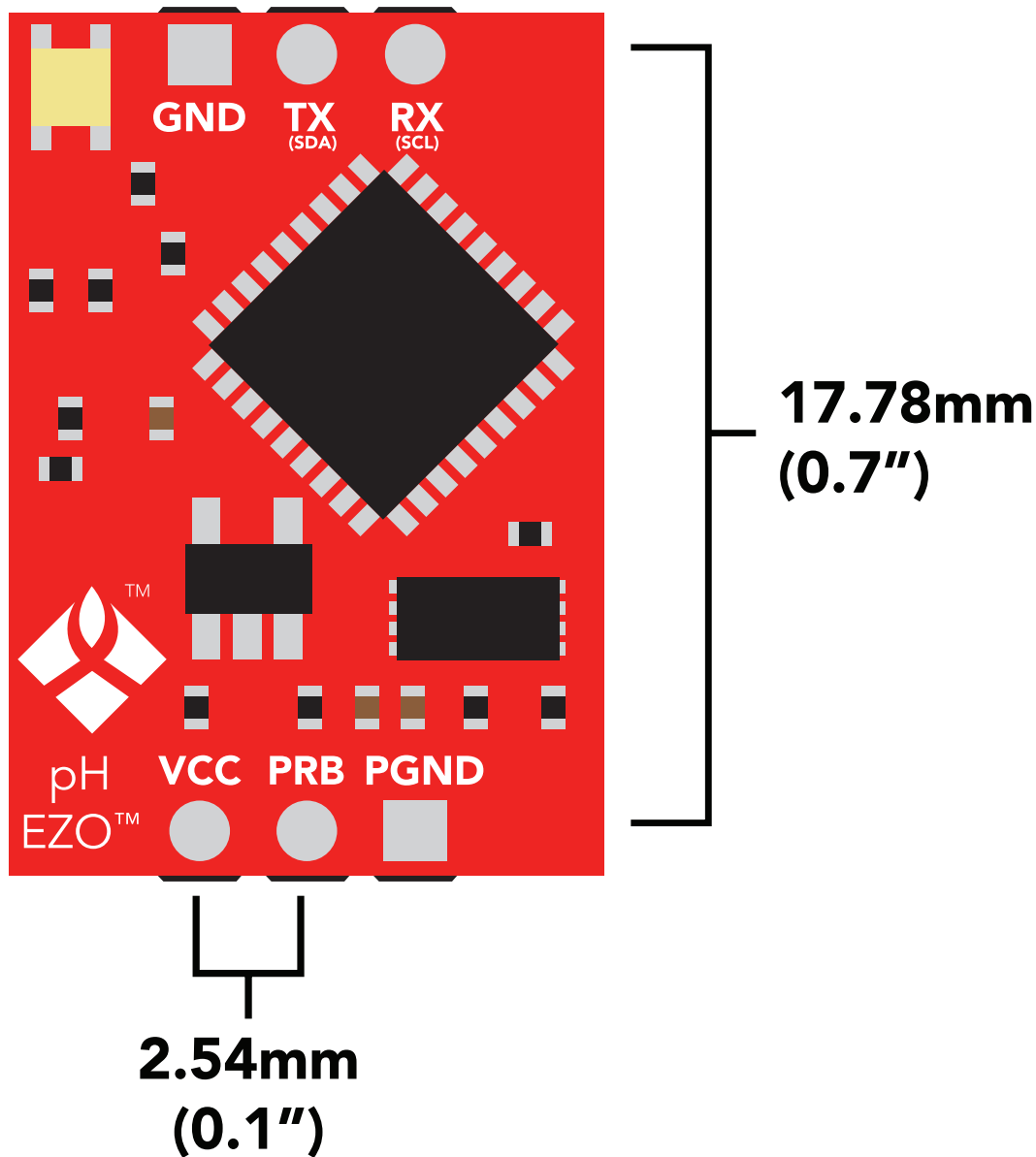

1 In your CAD software place an 8 position header.



2 Place a 3 position header at both top and bottom of the 8 position.

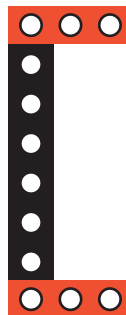

3 Delete the 8 position header. The two 3 position headers are now 17.78mm (0.7") apart from each other.

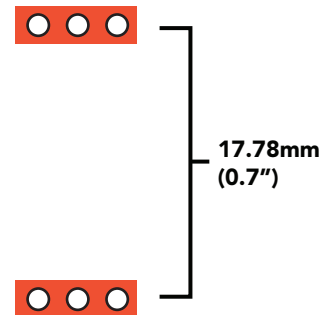

Datasheet change log

Datasheet V 4.5

Revised definition of response codes on pg 44.

Datasheet V 4.4

Added resolution range to cover page.

Datasheet V 4.3

Revised isolation information on pg 9.

Datasheet V 4.2

Revised Plock pages to show default value.

Datasheet V 4.1

Added new commands:

"Find" pages 23 & 46.

"Export/Import calibration" pages 27 & 49.

Added new feature to continuous mode "C,n" pg 24.

Datasheet V 4.0

Added accuracy range on cover page, and revised isolation info on pg. 10.

Datasheet V 3.9

Revised calibration theory on pg. 7.

Datasheet V 3.8

Revised entire datasheet.

Firmware updates

V1.1 – Initial release (Oct 30, 2014)

- Change output to mg/L, then percentage (was previously percentage, then mg/L)

V1.5 – Baud rate change (Nov 6, 2014)

- Change default baud rate to 9600

V1.6 – I²C bug (Dec 1, 2014)

- Fix I²C bug where the circuit may inappropriately respond when other I²C devices are connected.

V1.7 – Factory (April 14, 2015)

- Changed "X" command to "Factory"

V1.95 – Plock (March 31, 2016)

- Added protocol lock feature "Plock"

V1.96 – EEPROM (April 26, 2016)

- Fixed glitch where EEPROM would get erased if the circuit lost power 900ms into startup

V1.97 – EEPROM (Oct 10, 2016)

- Added the option to save and load calibration.

V1.98 – EEPROM (Nov 14, 2016)

- Fixed glitch during calibration process.

V2.10 – (May 9, 2017)

- Added "Find" command.
- Added "Export/import" command.
- Modified continuous mode to be able to send readings every "n" seconds.

V2.11 – (June 12, 2017)

- Fixed "I" command to return "pH" instead of "PH".

Warranty

Atlas Scientific™ Warranties the EZO™ class pH circuit to be free of defect during the debugging phase of device implementation, or 30 days after receiving the EZO™ class pH circuit (which ever comes first).

The debugging phase

The debugging phase as defined by Atlas Scientific™ is the time period when the EZO™ class pH circuit is inserted into a bread board, or shield. If the EZO™ class pH circuit is being debugged in a bread board, the bread board must be devoid of other components. If the EZO™ class pH circuit is being connected to a microcontroller, the microcontroller must be running code that has been designed to drive the EZO™ class pH circuit exclusively and output the EZO™ class pH circuit data as a serial string.

It is important for the embedded systems engineer to keep in mind that the following activities will void the EZO™ class pH circuit warranty:

- Soldering any part of the EZO™ class pH circuit.
- Running any code, that does not exclusively drive the EZO™ class pH circuit and output its data in a serial string.
- Embedding the EZO™ class pH circuit into a custom made device.
- Removing any potting compound.

Reasoning behind this warranty

Because Atlas Scientific™ does not sell consumer electronics; once the device has been embedded into a custom made system, Atlas Scientific™ cannot possibly warranty the EZO™ class pH circuit, against the thousands of possible variables that may cause the EZO™ class pH circuit to no longer function properly.

Please keep this in mind:

- 1. All Atlas Scientific™ devices have been designed to be embedded into a custom made system by you, the embedded systems engineer.**
- 2. All Atlas Scientific™ devices have been designed to run indefinitely without failure in the field.**
- 3. All Atlas Scientific™ devices can be soldered into place, however you do so at your own risk.**

Atlas Scientific™ is simply stating that once the device is being used in your application, Atlas Scientific™ can no longer take responsibility for the EZO™ class pH circuits continued operation. This is because that would be equivalent to Atlas Scientific™ taking responsibility over the correct operation of your entire device.